

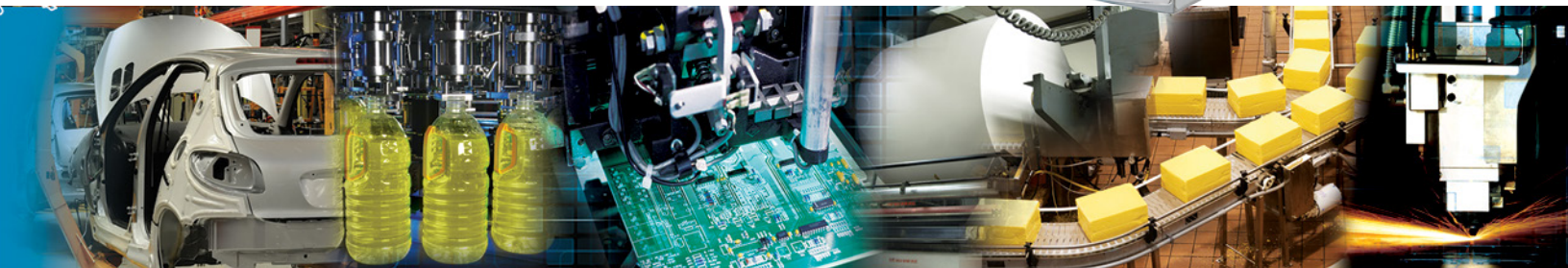

Sentronic^D | 608 Series and 609 Series

Proportional Technology



Sentronic^D

Sentronic^D is a digitally operated pressure regulator valve.

Sentronic^D stands for:

- Digital control
- Display (integrated)
- Direct operated valve

With the Data Acquisition Software (DaS) and the RS232 interface, it's now possible to optimally adjust the valve's control parameters to a specific application. The scope function allows you to log and read the system's response in real time.

The DaS capabilities streamline the development process and identify application-specific problems at an early stage. Saved parameters can also be used for future production so that valves are factory-set to a specific application.

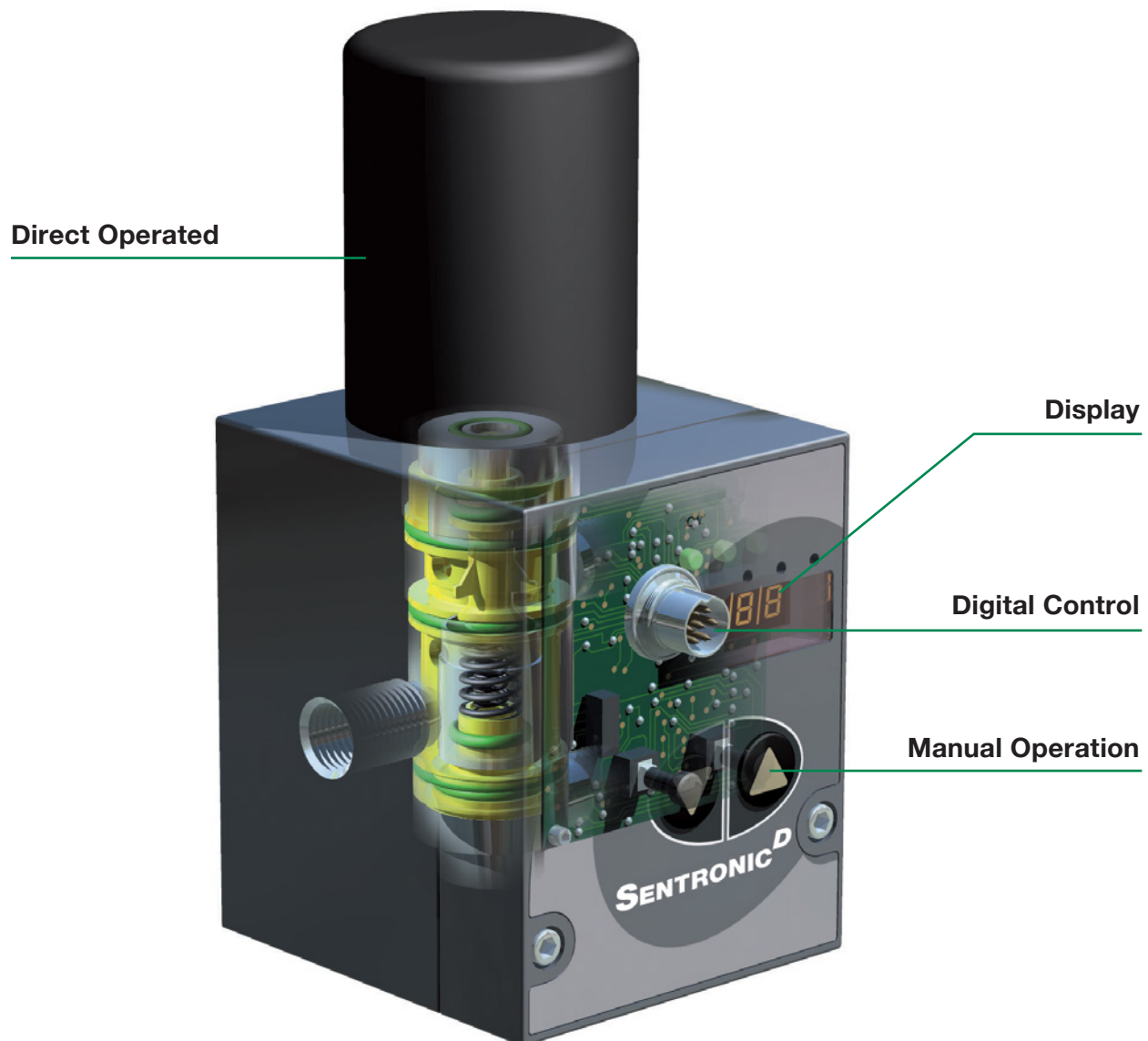

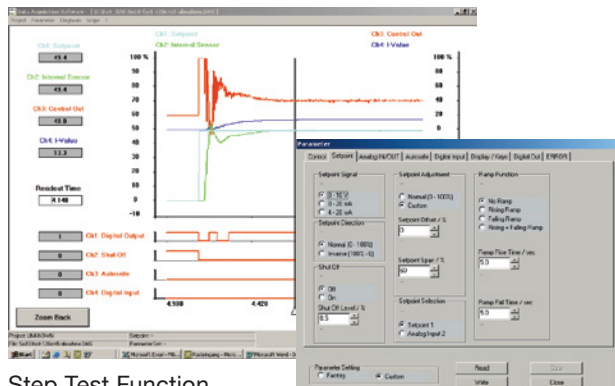

Step Test Function

Parameters Setup

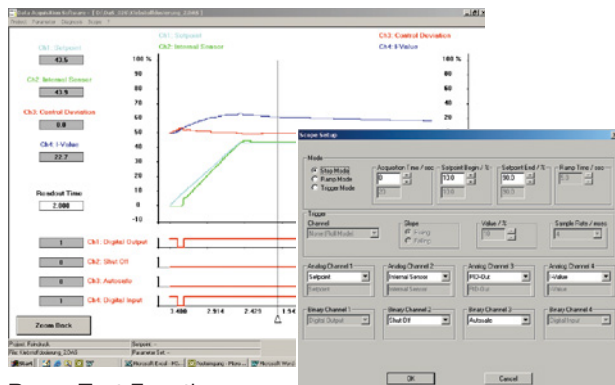

Ramp Test Function

Scope Setup

Advantages

- Minimum hysteresis
- Quick response times
- Very high sensitivity
- Standard 50 µm filtration
- No constant air consumption
- Analog feedback output
- Easy change of control parameters
- Digital control
- Integrated display (optionally without)
- PC communication

How to Order

608 6 C 0 1 1 1

<p>Nominal Diameter</p> <p>608 = DN 4mm 609 = DN 8mm</p> <p>Version (ports), Body</p> <p>0 = G 1/8 (DN4), G 1/4 (DN 8) 1 = G 1/4 (DN 4), G 3/8 (DN 8) 2 = Manifold version¹, G 1/4 (DN 4), G 3/8 (DN 8) 6 = NPT 1/4 (DN 4), NPT 3/8 (DN 8)</p> <p>Pressure Range</p> <table border="0"> <tr> <td style="text-align: center;">Max. Inlet Pressure</td> <td></td> <td style="text-align: center;">Max Inlet Pressure</td> </tr> <tr> <td>A = 0 - 50 psi</td> <td>90 psi</td> <td>1 = 0 - 10 bar</td> </tr> <tr> <td>B = 0 - 100 psi</td> <td>140 psi</td> <td>2 = 0 - 12 bar</td> </tr> <tr> <td>C = 0 - 150 psi</td> <td>190 psi</td> <td>3 = 0 - 3 bar</td> </tr> <tr> <td></td> <td></td> <td>4 = 0 - 1 bar</td> </tr> <tr> <td></td> <td></td> <td>5 = 0 - 15 bar</td> </tr> <tr> <td></td> <td></td> <td>6 = 0 - 6 bar</td> </tr> </table>	Max. Inlet Pressure		Max Inlet Pressure	A = 0 - 50 psi	90 psi	1 = 0 - 10 bar	B = 0 - 100 psi	140 psi	2 = 0 - 12 bar	C = 0 - 150 psi	190 psi	3 = 0 - 3 bar			4 = 0 - 1 bar			5 = 0 - 15 bar			6 = 0 - 6 bar	<p>Options</p> <p>A00 = Dual loop control 211 = Oxygen clean</p> <p>Display</p> <p>0 = without display 1 = with display</p> <p>Digital Output</p> <p>1 = Pressure switch output, PNP ± 5%</p> <p>Feedback</p> <p>1 = Feedback output 0 - 10 V 2 = Feedback output 0 - 20 mA 3 = Feedback output 4 - 20 mA 4 = Feedback input 0 - 10 Volt² 5 = Feedback input 0 - 20 mA² 6 = Feedback input 4 - 20 mA²</p> <p>Command Signal</p> <p>0 = 0 - 10 V 1 = 0 - 20 mA 2 = 4 - 20 mA</p>
Max. Inlet Pressure		Max Inlet Pressure																				
A = 0 - 50 psi	90 psi	1 = 0 - 10 bar																				
B = 0 - 100 psi	140 psi	2 = 0 - 12 bar																				
C = 0 - 150 psi	190 psi	3 = 0 - 3 bar																				
		4 = 0 - 1 bar																				
		5 = 0 - 15 bar																				
		6 = 0 - 6 bar																				

Notes:
¹ See Accessories section for required manifold subbase.
² Feedback input is needed for dual loop units.

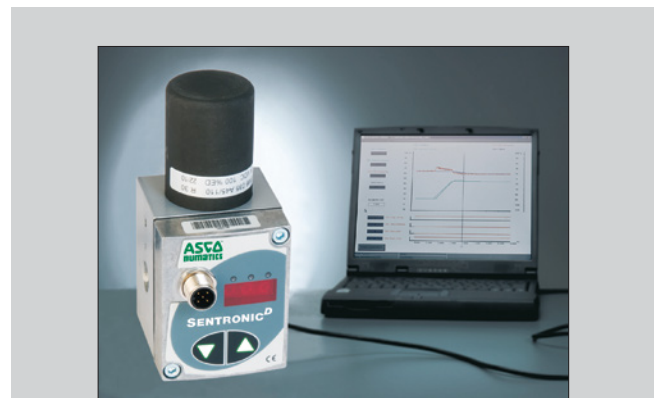

By connecting the Sentronic^o to a PC with an RS232 interface, the Data Acquisition Software (DaS) can be used to optimally adjust the valve's control parameters to a specific application. DaS has an oscilloscope function that allows the user to select and visually see various response characteristics as the valve operates in an application. Control loop parameters can be adjusted using the software without removing the valve from service. This functionality streamlines the application development process. Control parameters can be saved and reloaded at any time.

The DaS software offers the following features:

- Real time display of: command signal, outlet pressure, internal control parameters (e.g. P, I or D), pressure switch signal, etc.
- Parameter setting: command signal, zero offset, span, limitation of output current, ramp function, etc.
- Diagnostics menu for error detection and testing
- Custom adjustment to an application
- Control of Sentronic^o

Sentronic^D

1/8 to 3/8 tapped body or 1/8 - 1/4 subbase mounted body (NPT or GTap)

- Sentronic^D is a highly dynamic 3-way proportional valve with digital control
- Sentronic^D stands for:
 - Digital communication and control
 - Display (integrated)
 - Direct operated valve
- A special feature of the Sentronic^D is its DaS software supplied for optimum adjustment via PC and viewing of command and feedback signals
- Other functions are valve diagnostics, parameter setting and maintenance
- Sentronic^D can be configured for dual loop control of process variables such as flow, force, speed, RPM and temperature



Fluids	Ambient Temperature	Body	Internal Parts	Seals
Air or neutral gas, filtered at 50 µm, condensate-free, lubricated or unlubricated	0 °C to 50 °C (32 °F to 122 °F)	Aluminum	POM (polyacetal)	NBR (nitrile) and FPM (fluoroelastomer)

General Valve Information	
Fluid Temperature	0 °C to 60 °C (32 °F to 140 °F)
Flow (Qv at 6 bar)	470 to 1300 l/min (ANR)
Command Signal	0 – 10 V (impedance 100 kΩ), 0 – 20 mA, – 20 mA (impedance 250 Ω)
Ports	1/8, 1/4, 3/8 (NPT or GTap)
Construction	Poppet Valve
Actuation	Proportional Solenoid
Hysteresis	< 1% of span
Linearity	< 0.5% of span
Repeatability	< 0.5% of span
Minimum Setpoint	100 mV (0.2 mA/4.2mA) with shut-off function
Minimum Outlet Pressure	1% of span

Electrical Characteristics						
Nominal Diameter DN (mm)	Voltage *	Max. Power (W)	Max. Current (mA)	Insulation Class	Degree of Protection	Electrical Connection
4	24 VDC = ± 10%	21	850	H	IP65	5-pin M12 connector (not supplied)
8	24 VDC = ± 10%	40	1650	H	IP65	5-pin M12 connector (not supplied)

* Max. ripple: 10%

Specifications			
Ø Ports	Ø Orifice DN (mm)	Flow	
		C _v Flow Factor (K _v Nm ² /h)	at 6 Bar (l/min - ANR)
1/8, 1/4 NPT or GTap	4	0.50 (0.43)	470
1/4, 3/8 NPT or GTap	8	1.39 (1.20)	1300

Dimensions: inches (mm)

Inline version: DN 4

Weight: 0.56kg (1.23lbs)

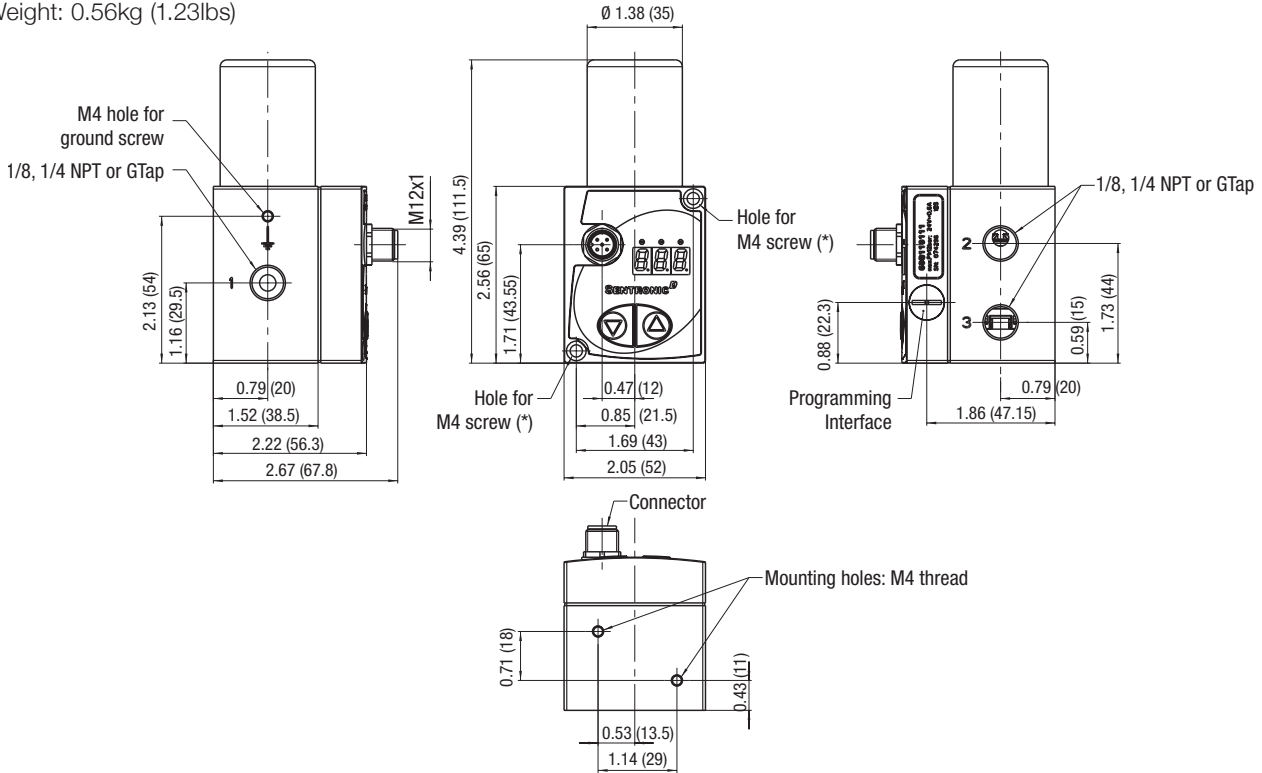

Inline version: DN 8

Weight: 1.13kg (2.49lbs)

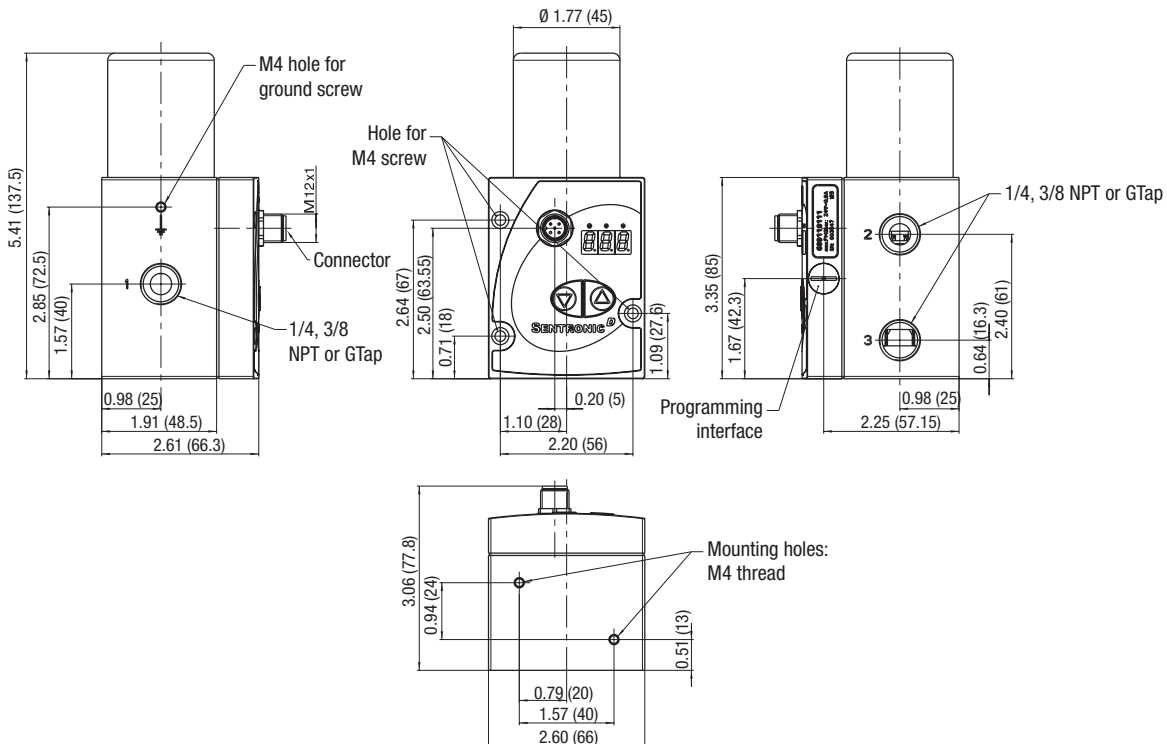

Dimensions: inches (mm)

Manifold version: DN 4

Weight: 0.56kg (1.23lbs)

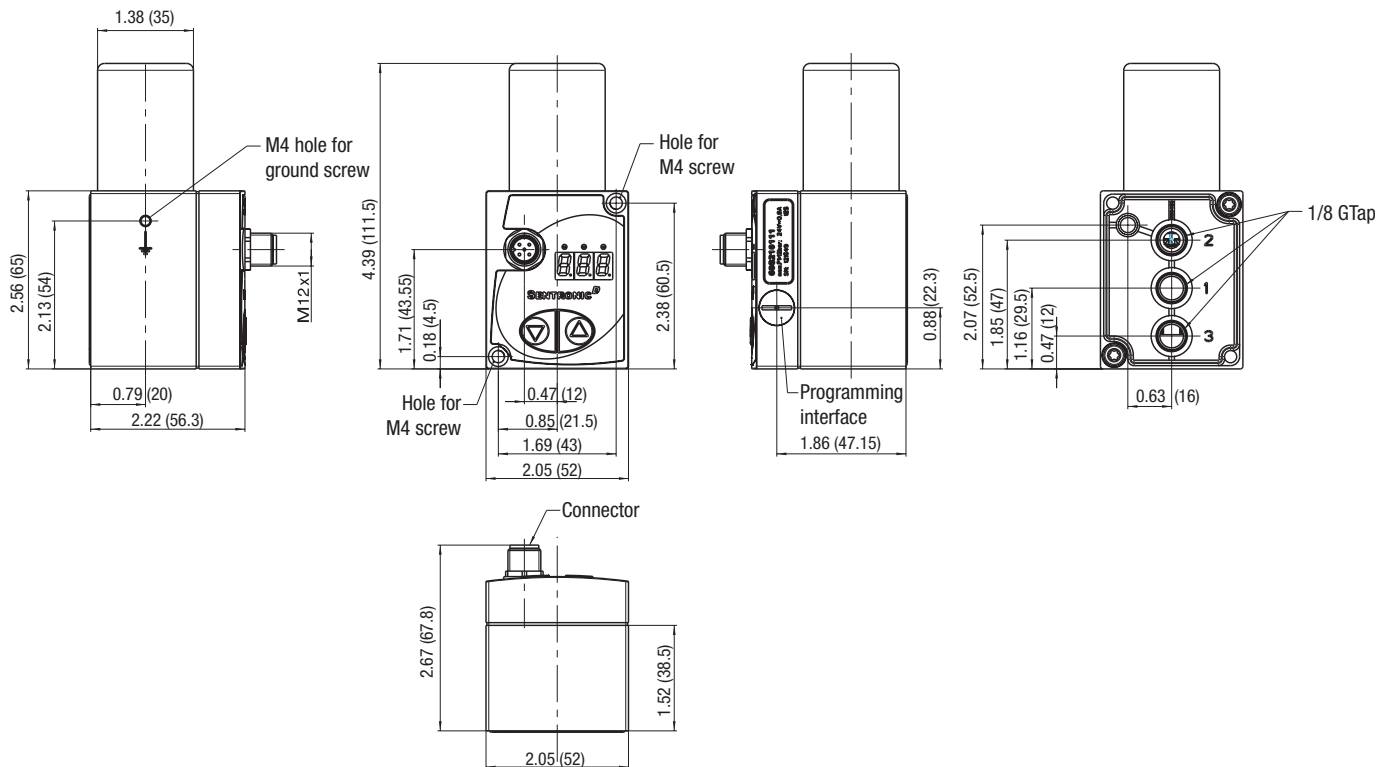

Manifold: DN 4

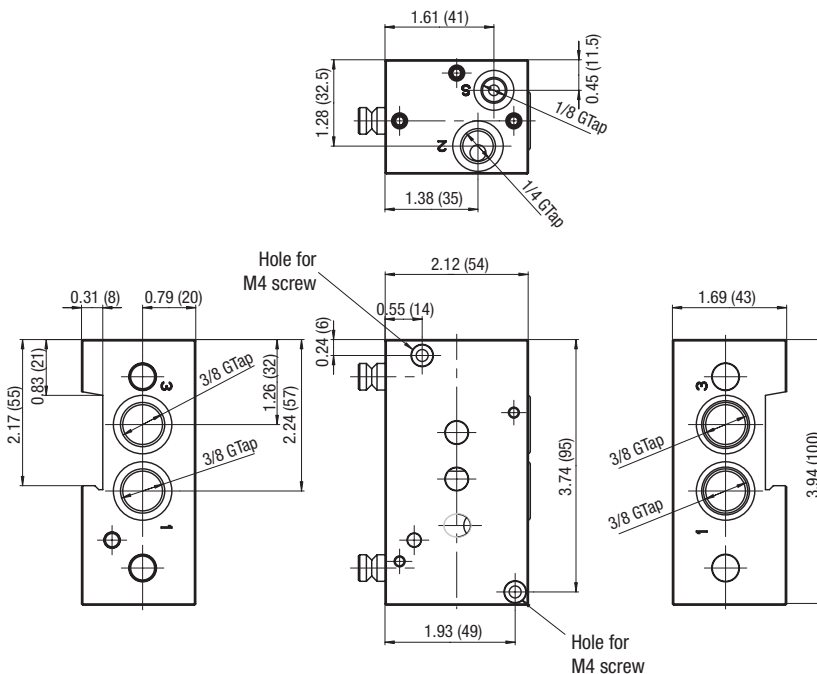

Dimensions: inches (mm)

Manifold version: DN 8

Weight: 1.13kg (2.49lbs)

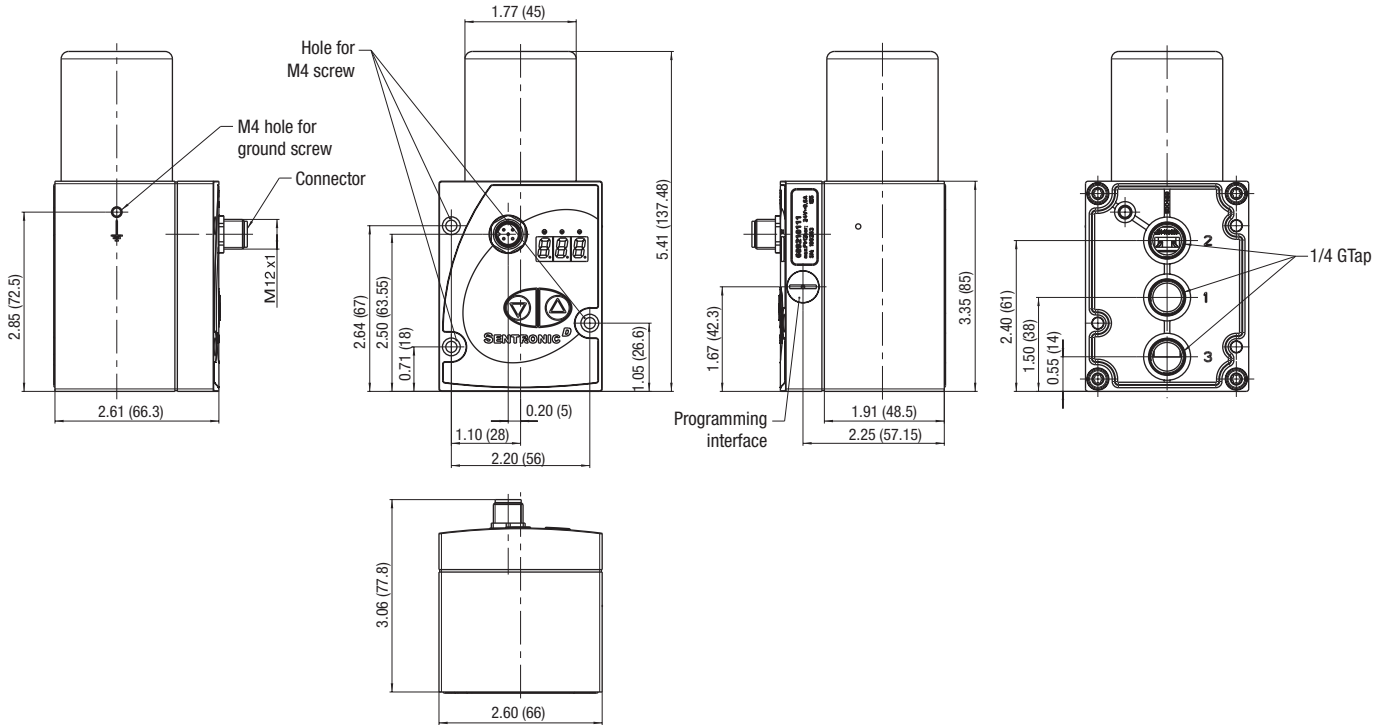

Manifold: DN 8

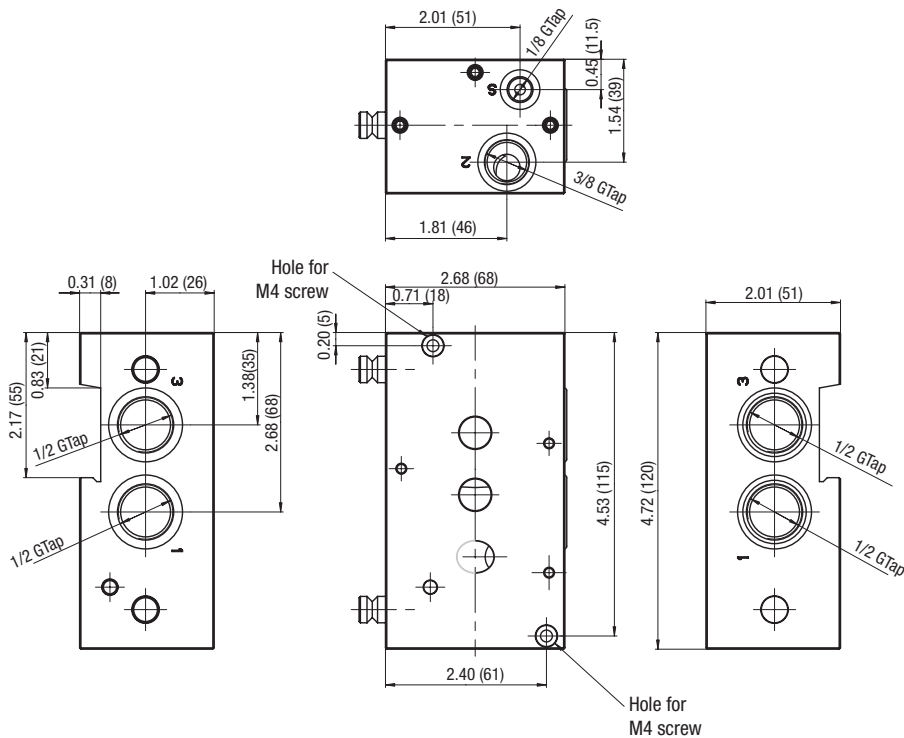

Connector Pin Out

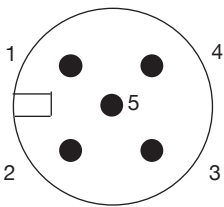

Pin	Description
1	+24 VDC Supply
2	Command Signal
3	+0 VDC Common (Supply)
	+0 VDC Common (Command Signal)*
4	Analog output (feedback)
5	Digital output (pressure switch)
Body	EMC shield

* A 6-wire cable with separate common for the command signal is used for cable lengths over 2m to minimize the voltage drop for the command signal.

Accessories



5 Pin 12mm FEMALE Straight Field Attachable Connectors	Model Number
PG 9 Cable Gland	TC05F20000000000



5 Pin 12mm FEMALE 90 DEGREE Field Attachable Connectors	Model Number
PG 9 Cable Gland	TD05F20000000000



Micro Female 5 Pole Straight 6 Wire 24 AWG, Shielded	Model Number
3 Meter	TC0503MMS000671Y
5 Meter	TC0505MMS000671Y



Micro Female 5 Pole 90 Degree 6 Wire 24 AWG Euro Color Code, Shielded	Model Number
3 Meter	TD0503MMS000671Y
5 Meter	TD0505MMS000671Y



Micro F/M 4 Pole Straight 22 AWG Euro Color Code	Model Number
Unshielded	Shielded
2 Meter - TC0403MIETA04000	3 Meter - TC0403MMETA04000
5 Meter - TC0405MIETA04000	5 Meter - TC0405MMETA04000



Micro F 90°/M Straight 22 AWG Euro Color Code	Model Number
Unshielded	Shielded
2 Meter - TD0403MIETA04000	3 Meter - TD0403MMETA04000
5 Meter - TD0405MIETA04000	5 Meter - TD0405MMETA04000

Manifold (individual subbases that join together)	Model Number
Manifold for 608 (DN 4mm) with G3/8; supply/exhaust and G1/4 output	35500558
Manifold for 609 (DN 8mm) with G1/2; supply/exhaust and G3/8 output	35500559

PC Software & Cable Connectors	Model Number
DaS Light: Data Acquisition Software for Sentronic ^D - basic parameters - free download at asco.com	99100110
DaS Expert: Data Acquisition Software for Sentronic ^D - full parameters	Consult Factory
RS 232 cable converter; 2m cable with 9-pin Sub-D (connector required for software usage)	88100732

¹ Manifold ships with required hardware and gaskets for connecting manifolds together.