

Proportional Technology

Precise Control of Pressure and Flow

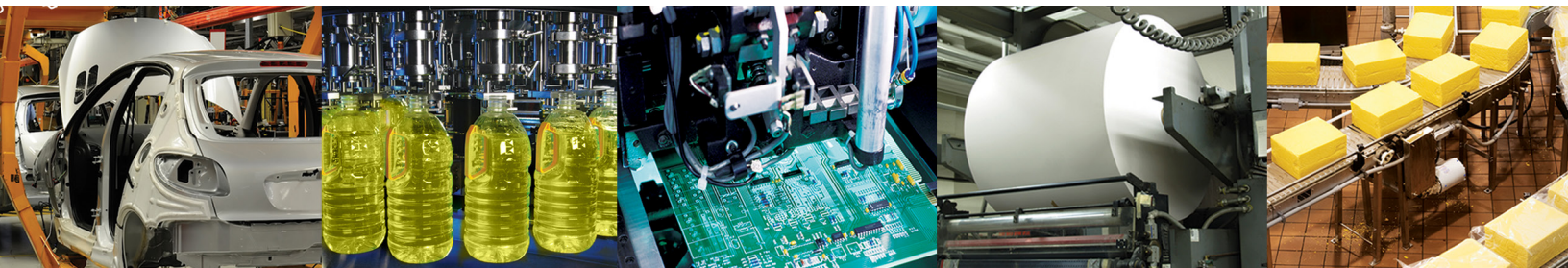

| | |
|---|----|
| Introduction to Control Technology | |
| Glossary of Terms | 2 |
| Control Systems/Control Methods | 4 |
| Types of Contollers | 5 |
| Applications for Proportional Valves | |
| For Economical Quality and Control | 6 |
| Application Examples | 7 |
| Selection of Proportional Valves | |
| Technical Characteristics | 10 |
| Choice of Equipment | 11 |
| Pressure Control | |
| 608/609 Series Sentronic ^D | 12 |
| 614 Series Sentronic ^{PLUS} | 19 |
| 616 Series Sentronic ^{HD} | 25 |
| 617 Series Sentronic ^{LP} | 29 |
| 615 Series Servotonic ^{Digital} | 35 |
| Flow Control | |
| 607 Series Flowtronic ^D | 40 |
| Accessories | |
| 603 Series Control ^D | 45 |



Symbols and Terminology

Glossary of Terms

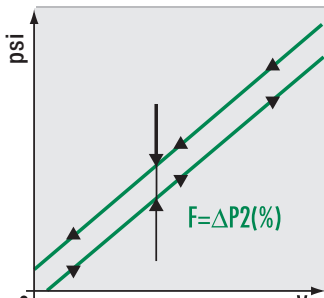

Hysteresis

Hysteresis is the tolerance of the outlet pressure for a given command signal depending on whether the previous pressure was higher or lower.

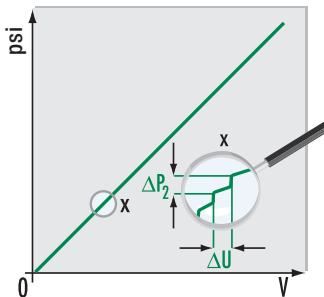

Sensitivity

The smallest change in command signal which leads to a change in the outlet pressure is called sensitivity. Expressed as a percentage of the maximum outlet pressure.

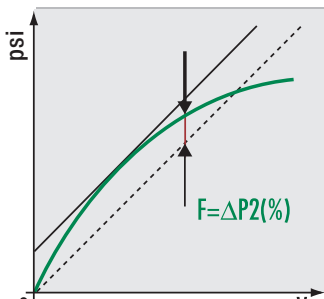

Linearity

The ideal relationship between command signal and outlet pressure is linear, and when plotted results in a straight line (dotted line). Linearity is a measure of the maximum deviation between the actual outlet pressure and commanded pressure.

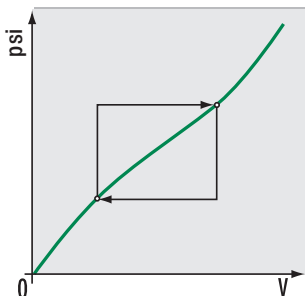

Repeatability

Repeatability is the tolerance of the outlet pressure for the same command signal given multiple times.

Symbols

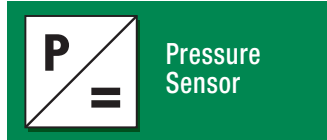

Pressure Sensor

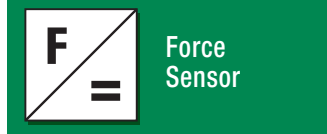

Force Sensor

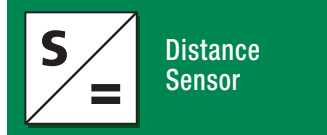

Distance Sensor

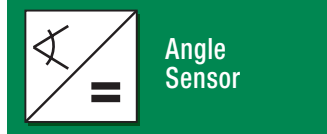

Angle Sensor

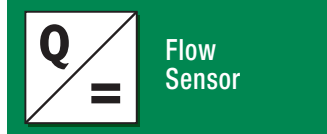

Flow Sensor

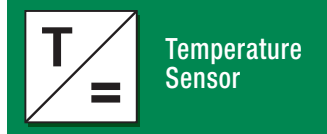

Temperature Sensor



Potentiometer

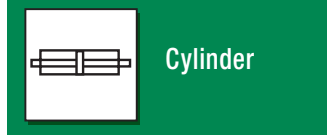

Cylinder

Symbols

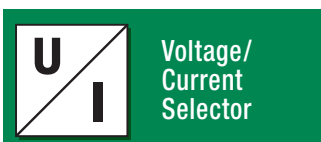
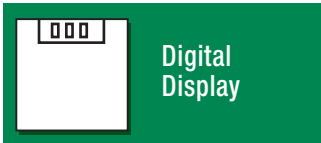
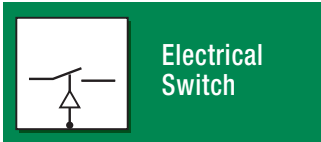

Zero Adjustment

The pressure or flow that corresponds with the lowest command signal.

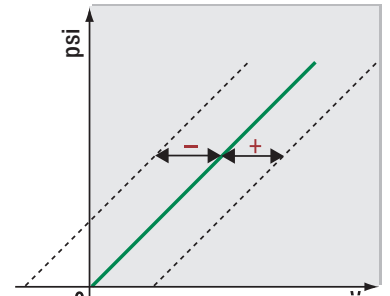

Span Adjustment

The valve's output pressure or flow range can be reduced to match the application's needs, providing the highest possible resolution.

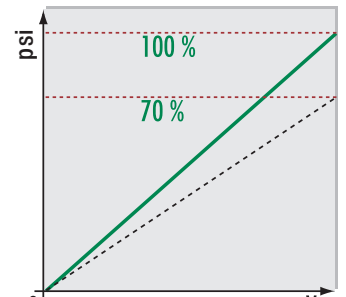

Ramp Function

The ramp function transforms a command signal step into an internal gradual increase. This allows slow opening and closing of proportional valves.

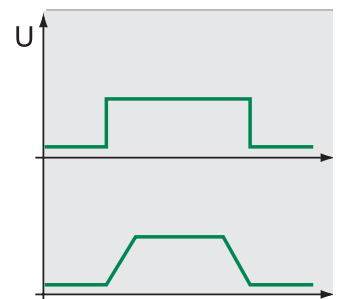

Ripple Frequency

Modulation voltage to minimize friction (slip-stick) in a valve.

Feedback Value

Actual electrical value of a physical variable. (Pressure, force, temperature, flow, etc.)

Control Systems

Within industrial automation, the goal of a control system is to move a physical variable such as temperature, pressure, force or displacement to a predetermined value. The complexity of the system, impact of external variables and required accuracy will dictate whether the control system needs some type of feedback measurement in order to ensure that the desired value (or setpoint) is reached. The difference between open-loop and closed-loop control is that the feedback allows the control system, or control loop, to compare the output to the commanded value and adjust as needed.

Open-Loop Control

An example of an open control loop is a timer for a sprinkler system. When the timer is activated, the sprinkler goes on for a set amount of time. This is open-loop control because the system does not monitor, for instance, the moisture content of the soil. The system will turn the sprinklers on in the middle of a rainstorm. The desired outcome of the controlled action is not monitored.

An open sequence of actions where there is no comparison of the end result to the desired result is the primary characteristic of open-loop control.



Open-Loop Control

Closed-Loop Control

In a closed loop, the desired value or setpoint is constantly compared to the actual value. DIN standard 19226 defines the terms “Control and Adjustment” as follows: “Control and adjustment is an operation in which a physical variable (e.g. temperature, pressure etc.) is continuously measured and compared to a previously specified value of the variable with the aim of matching the two. The resulting closed sequence of actions occurs in a closed loop, the closed-control loop.”

In the example of the sprinkler system, the actual moisture content of the soil could be measured with a sensor and compared to the desired moisture level. As soon as there is a difference between the desired value and measured value, a signal can be sent to either open the water valve (if the soil is dryer than specified) or close the valve (if the soil is wetter than specified). The feedback, provided by the sensor in this case, that is used to compare and adjust the actual value to the desired value is the primary characteristic of a closed-loop system.

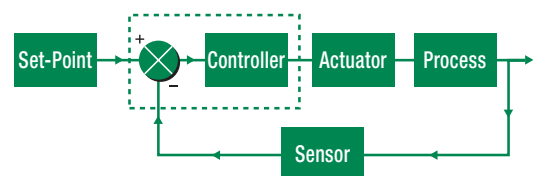

Closed-Loop Control

Types of Controllers

A controller is a transfer element which compares the feedback value received from a transducer (sensor) to a predetermined value (i.e. setpoint) and processes it in such a way that a control signal is transmitted to the actuating element (e.g. a proportional valve). The controller should control this transmission in such a way that the dynamic qualities of the controlled process are balanced. The setpoint should be reached quickly while the feedback value should fluctuate as little as possible around the setpoint.

ASCO's proportional valves use a common controller called a proportional-integral-derivative (PID) controller. The P, I and D terms can easily be modified with each product's software to achieve various types of control based upon the needs of a given application. The most basic controller is the P controller. P, PI and PID control are best suited to a wide range of applications.

The charts to the right show graphical representations of the various PID terms and the table below shows the types of controllers that are most often successful by application.

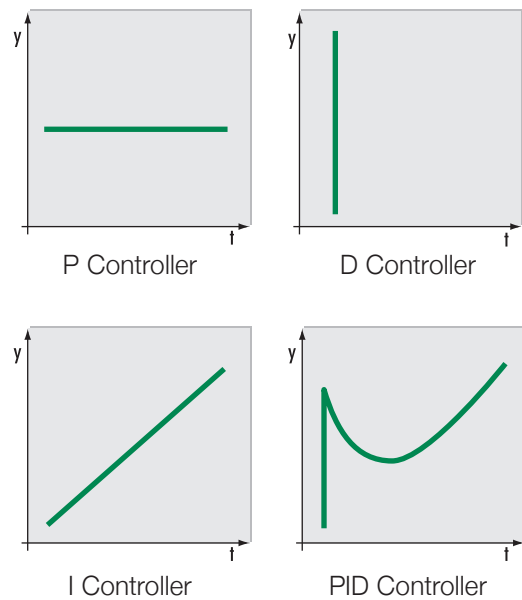

| Application | Types of Controllers | | |
|-------------|----------------------|------------|---------------|
| | P | PI | PID |
| Pressure | low profile | suitable | suitable |
| Flow | unsuitable | suitable | less suitable |
| Temperature | low profile | suitable | suitable |
| Level | suitable | unsuitable | unsuitable |
| Speed | suitable | suitable | suitable |

For Economical Quality and Control...

Proportional valves maximize production processes in many industries including food processing, textiles, industrial plant engineering, medical technology, pharmaceutical, semiconductor, and automobile. These valves create many innovative solutions when incorporated into a programmable control system. The combination of electronics and mechanics in proportional valves provides ideal performance for many industrial applications. ASCO's proportional pressure regulators and flow control valves are highly customizable to specific applications. ASCO continually develops customized components and solutions for specific customer requirements. Please do not hesitate to contact ASCO's technical support team.

Spot Welding

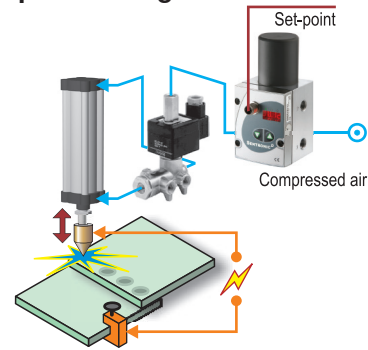

The proportional pressure regulator controls the clamping force of the welding head depending on the material to be welded and its thickness.

Compensation of Thickness

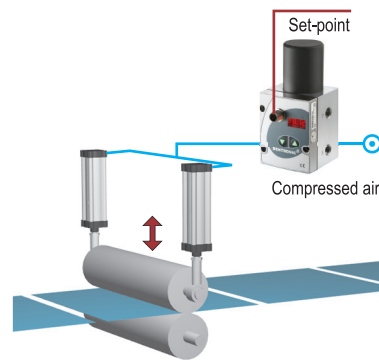

The pressure acting against the roller is controlled with a proportional pressure regulator. Different thickness in the materials is offset.

Servo Unit for Brakes

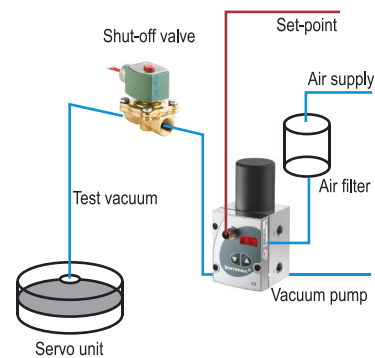

The proportional pressure regulator is incorporated in the bypass of a vacuum pump. The brake booster is checked against the setpoint.

Force

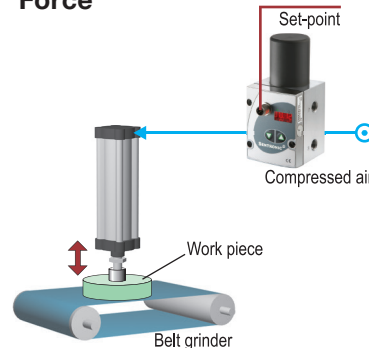

The proportional valve controls the force acting against work pieces on grinding belts, pneumatic presses etc.

Control of Pressure and Flow

Paint Spray Gun Application

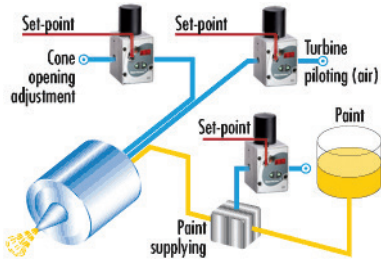

Spray gun control: Control of paint flow and spray density, and of the surface of the part of being painted.

Glue Dosing

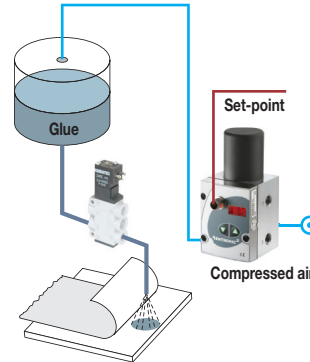

The proportional pressure regulator maintains system pressure as the level of glue in the container decreases. Glue is dosed accordingly.

Material Testing

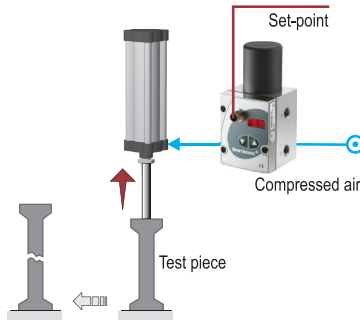

The force acting against the test piece is continuously increased until the test piece is destroyed.

Vacuum Generation

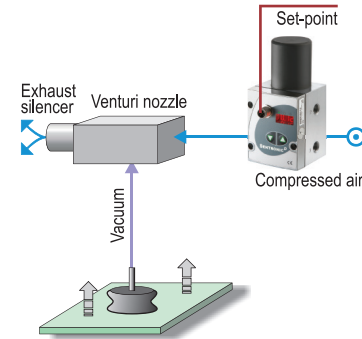

A change of pressure into the venturi nozzle via the proportional valve changes the vacuum generated.

Fluid Coating

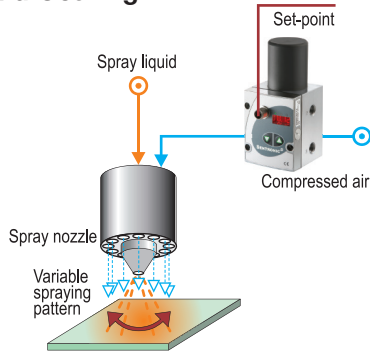

The spray pattern, i.e. the coating width, is adjusted by controlling the air supply through fan adjusting nozzles.

Flight Simulator

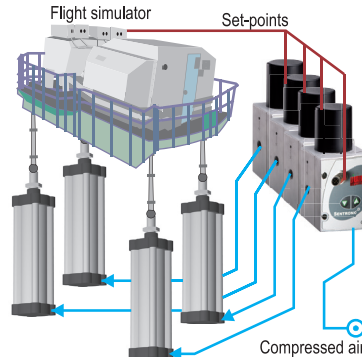

The movements of an aircraft are simulated by applying different pilot pressures to the cylinders.

Brake Pressure

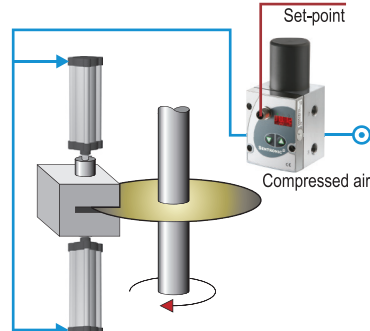

A command signal is used to gradually brake and slow down a rotating mass in accordance with the controller's speed profile.

Leak Test

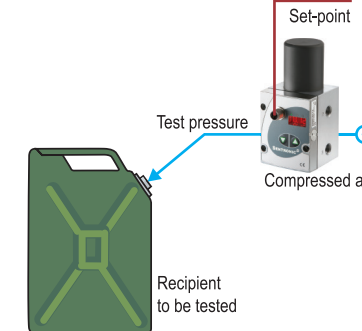

The proportional pressure regulator precisely adjusts the test pressure for different leak tests.

Control of Pressure and Flow

Laser Cutting

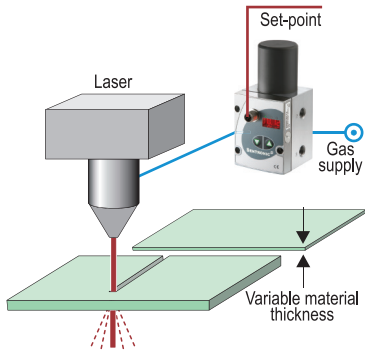

The gas pressure is adjusted in accordance with the material and its thickness.

Ultrasonic Welding

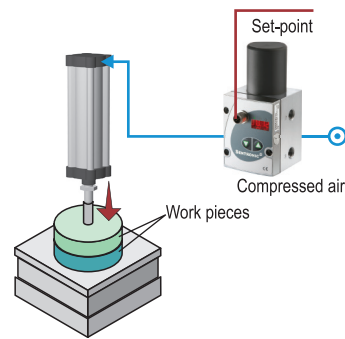

The proportional pressure regulator adjusts the frictional pressure of ultrasonic welding machines.

Bottle Molding

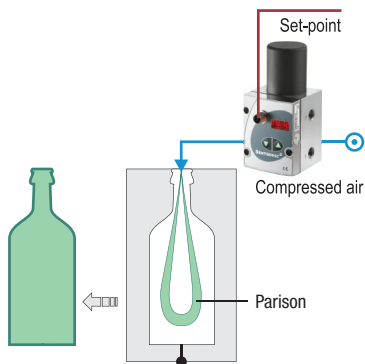

The parison is inflated at a varying rate using a proportional valve.

Turbo-Supercharger

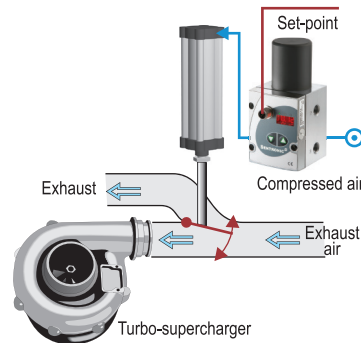

Exhaust gas flow is adjusted to the turbo-supercharger depending on the engine speed to maintain the charging pressure at a constant level.

Dual Loop Control

Sentronic^D, Sentronic^{PLUS} and Flowtronic^D can be configured for dual loop control. Process variables such as pressure, flow, force, speed, RPM, and temperature can be controlled. Dual loop control requires no additional components other than a process sensor to provide an analog feedback input.

Control of Speed and Torque

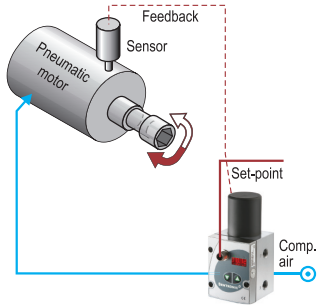

Speed and torque are controlled by changing the pilot pressure.

Tire Making

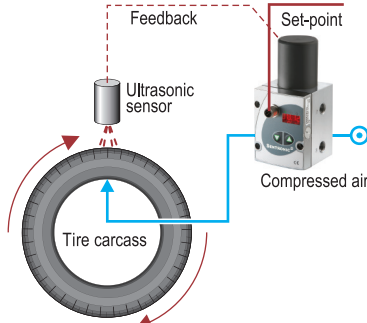

Controlled by the proportional pressure regulator with a dependence on the tire's diameter, the individual plies of the tires are built up and a constant tire quality is ensured.

Filling Pressure

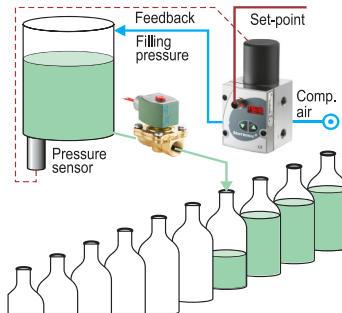

The liquid flows to the valve at a constant pressure irrespective of the fluid level in the storage tank. The filling volume remains constant.

Flow Control

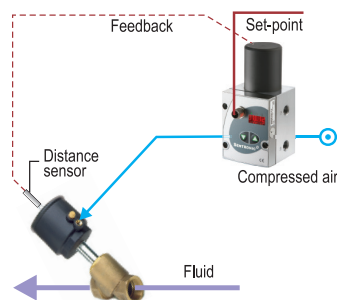

The flow of liquids is varied by continually adjusting the orifice of the fluid valve by measuring the valve's travel (distance sensor).

Compensation of Lengths in Winding

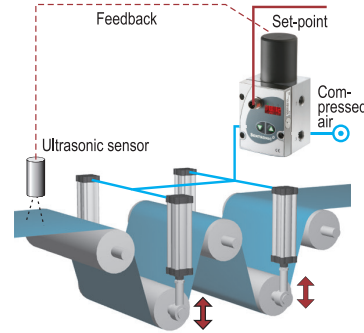

Different lengths of winding material are offset with cylinders controlled by proportional pressure regulators, which controls the tensile stress.

Balancer

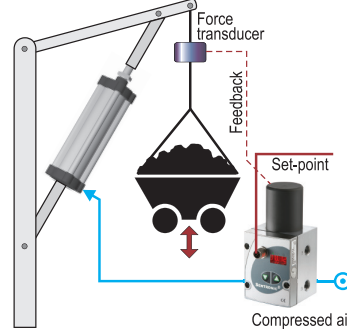

The proportional valve pneumatically balances the weight over the cylinder pressure. Heavy loads can easily be lifted and lowered by hand.

Temperature Control

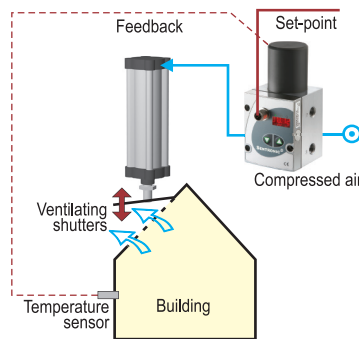

The room temperature is held at a constant level by opening or closing ventilating shutters.

Clamping Pressure Control

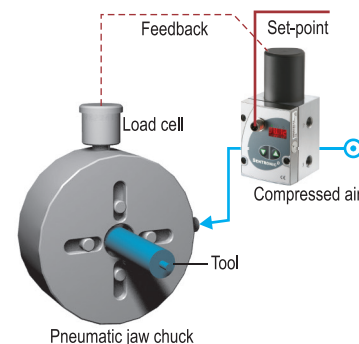

The clamping pressure of machine tools is adjusted in accordance with the tool's material (steel, synthetic material, etc.).

Technical Characteristics



| | Port size | Pressure range | Flow | Filtration | Hysteresis | Power rating | Type of construction | Loss of power behavior |
|-------------------------------------|------------------------------|-------------------------------|-------------------------------------|------------|------------------|--------------|-----------------------------------|------------------------------------|
| SENTRONIC^D | 1/8, 1/4, 3/8 NPT or GTap | 0 to 150 psi 0 to 10 bar | up to 45.9 SCFM 1300 NI/min | 50 µm | < 1% | 21 to 40 W | Poppet valve | Pressure released |
| SENTRONIC^{PLUS} | 1/8, 1/4, 1/2, 1 NPT or GTap | 0 to 725 psi 0 to 50 bar | up to 198 SCFM 5600 NI/min | 50 µm | < 1% | 33 to 44 W | Poppet valve | Pressure released |
| SENTRONIC^{HD} | 1/4 GTap | 0 to 145 psi 0 to 10 bar | 42 SCFM 1200 NI/min | 50 µm | ± 0.25 % of span | 5 W | Proportional Pilot + Poppet valve | Pressure released or pressure held |
| SENTRONIC^{LP} | 1/4, 3/8, 1/2, NPT or GTap | 0 to 150 psi 0 to 10.2 bar | up to 185 SCFM 5200 NI/min | 50 µm | < 1% | 3.8 W | Pilot + Poppet valve | Pressure held |
| SERVTRONIC^{Digital} | G 3/8 | 0 to 580 psi 0 to 40 bar | 60 SCFM 1700 NI/min | 5 µm | < 0.5% | 28 W | Spool-Sleeve Assembly | Pressure released |
| FLOWTRONIC^D | 1/4, 3/8, 1/2 NPT or GTap | 58 to 116 psi 4 to 8 bar | 0.4 to 70 SCFM 10 to 2000 NI/min | 50 µm | < 3% | 33 to 44 W | Poppet valve | Pressure released |

Choice of Equipment



| | Control | | Fluids | | | | Control loop | | Actuation | | Application | | Special features |
|-------------------------------------|----------|------|--------|-------------------|---------|-------|--------------|--------|------------|-------------|-------------|---------|--|
| | Pressure | Flow | Vacuum | Air/neutral gases | Liquids | Steam | Open | Closed | Electrical | Air piloted | Static | Dynamic | |
| SENTRONIC^D | ● | ○ | | ● | | | | ● | ● | | ■ | ▲ | Digital control with or without display, controller adaptation |
| SENTRONIC^{PLUS} | ● | ○ | ● | ● | | | | ● | ● | | ■ | ▲ | Digital control with or without display, controller adaptation |
| SENTRONIC^{HD} | ● | ○ | ● | ● | | | | ● | | ● | ■ | ▲ | Alternate between 3 saved sets of control parameters |
| SENTRONIC^{LP} | ● | ○ | | ● | | | | ● | | ● | ■ | | Low power consumption, controller adaptation |
| SERVTRONIC^{Digital} | ● | ○ | | ● | | | | ● | ● | | ■ | ▲ | Digital control, controller adaptation |
| FLOWTRONIC^D | | ● | | ● | | | | ● | ● | | ■ | ▲ | Digital control with or without display, controller adaptation |

- **Static:** For applications with few setpoint changes
- ▲ **Dynamic:** For applications with constantly changing setpoints
- **Primary function**
- **Secondary function**

Sentronic^D

Sentronic^D is a digitally operated pressure regulator valve.

Sentronic^D stands for:

- Digital control
- Display (integrated)
- Direct operated valve

With the Data Acquisition Software (DaS) and the RS232 interface, it's now possible to optimally adjust the valve's control parameters to a specific application. The scope function allows you to log and read the system's response in real time.

The DaS capabilities streamline the development process and identify application-specific problems at an early stage. Saved parameters can also be used for future production so that valves are factory-set to a specific application.

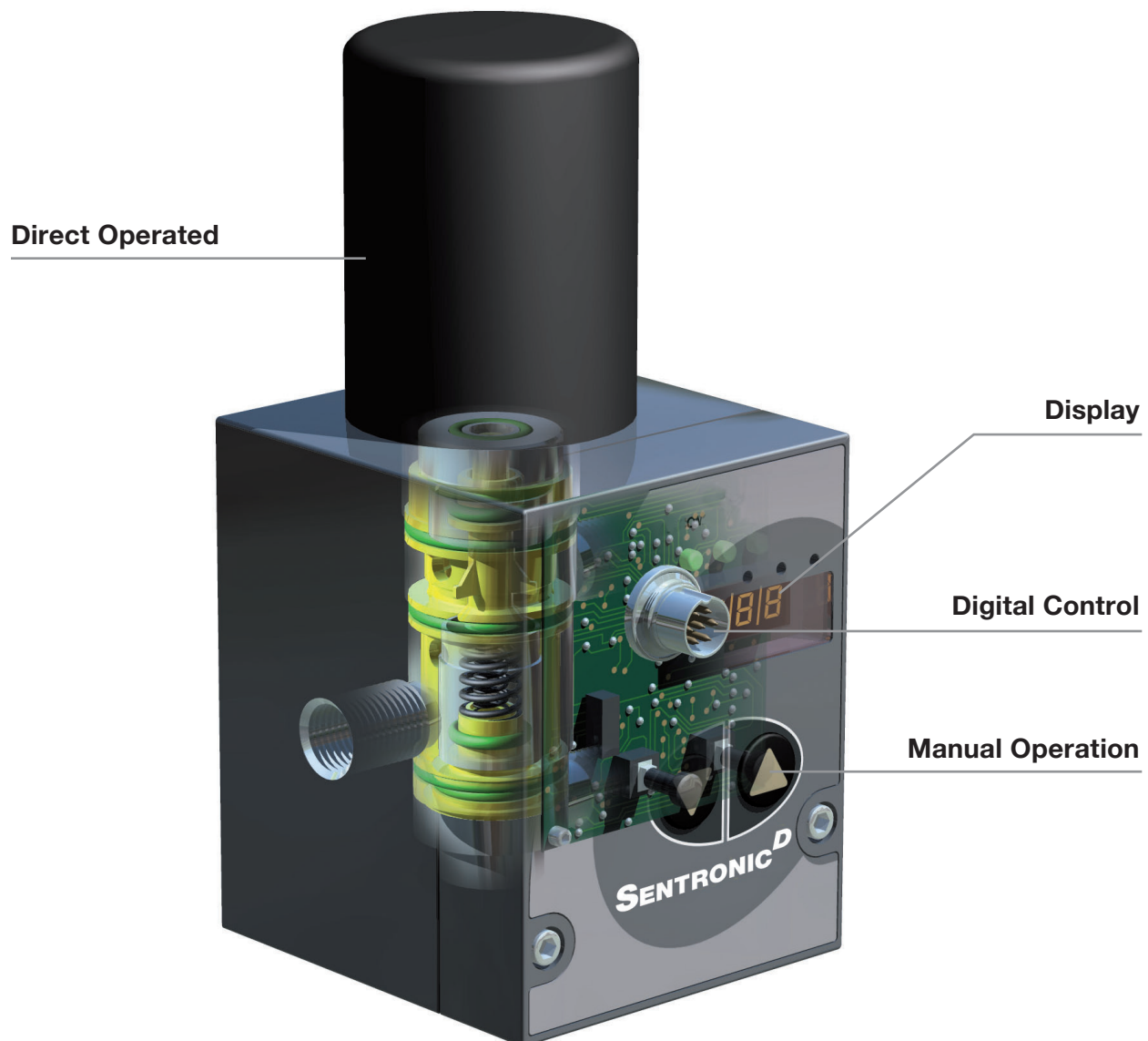

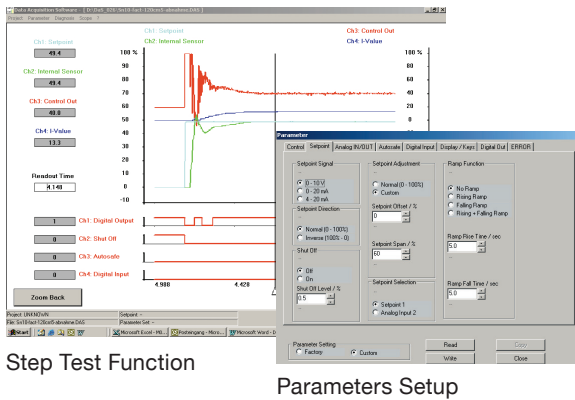

Step Test Function

Parameters Setup

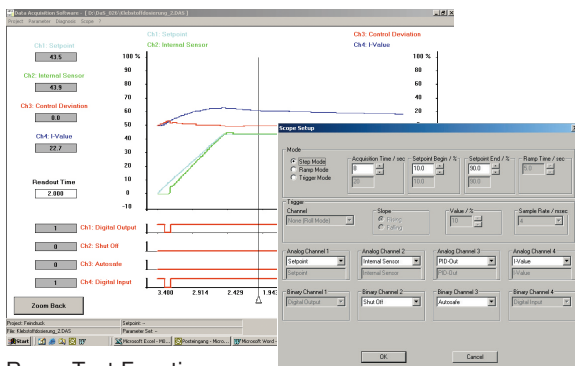

Ramp Test Function

Scope Setup

Advantages

- Minimum hysteresis
- Quick response times
- Very high sensitivity
- Standard 50 µm filtration
- No constant air consumption
- Analog feedback output
- Easy change of control parameters
- Digital control
- Integrated display (optionally without)
- PC communication

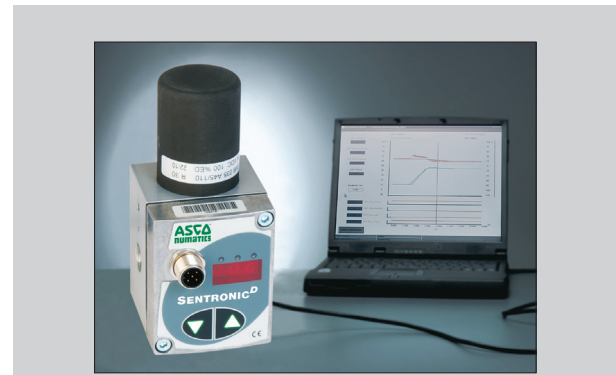

By connecting the Sentronic^o to a PC with an RS232 interface, the Data Acquisition Software (DaS) can be used to optimally adjust the valve's control parameters to a specific application. DaS has an oscilloscope function that allows the user to select and visually see various response characteristics as the valve operates in an application. Control loop parameters can be adjusted using the software without removing the valve from service. This functionality streamlines the application development process. Control parameters can be saved and reloaded at any time.

The DaS software offers the following features:

- Real time display of: command signal, outlet pressure, internal control parameters (e.g. P, I or D), pressure switch signal, etc.
- Parameter setting: command signal, zero offset, span, limitation of output current, ramp function, etc.
- Diagnostics menu for error detection and testing
- Custom adjustment to an application
- Control of Sentronic^o

How to Order

608 6 C 0 1 1 1

| | | | | | | | | | | | | | | | | | | | | | | | | | | | | | |
|---|----------------------------|----------------------------|---------------------------|---------------------------|---|------------------------|---|------------------------|---|--------------------------|---|------------------------|---|--------------------------|---|----------------------|--|--|---|----------------------|--|--|---|------------------------|--|--|---|----------------------|---|
| <p>Nominal Diameter</p> <p>608 = DN 4mm 609 = DN 8mm</p> <p>Version (ports), Body</p> <p>0 = G 1/8 (DN4), G 1/4 (DN 8) 1 = G 1/4 (DN 4), G 3/8 (DN 8) 2 = Manifold version¹, G 1/4 (DN 4), G 3/8 (DN 8) 6 = NPT 1/4 (DN 4), NPT 3/8 (DN 8)</p> <p>Pressure Range</p> <table border="0"> <tr> <td></td> <td style="text-align: center;">Max. Inlet Pressure</td> <td></td> <td style="text-align: center;">Max Inlet Pressure</td> </tr> <tr> <td>A</td> <td>= 0 - 50 psi 90 psi</td> <td>1</td> <td>= 0 - 10 bar 13 bar</td> </tr> <tr> <td>B</td> <td>= 0 - 100 psi 140 psi</td> <td>2</td> <td>= 0 - 12 bar 15 bar</td> </tr> <tr> <td>C</td> <td>= 0 - 150 psi 190 psi</td> <td>3</td> <td>= 0 - 3 bar 6 bar</td> </tr> <tr> <td></td> <td></td> <td>4</td> <td>= 0 - 1 bar 2 bar</td> </tr> <tr> <td></td> <td></td> <td>5</td> <td>= 0 - 15 bar 18 bar</td> </tr> <tr> <td></td> <td></td> <td>6</td> <td>= 0 - 6 bar 9 bar</td> </tr> </table> | | Max. Inlet Pressure | | Max Inlet Pressure | A | = 0 - 50 psi 90 psi | 1 | = 0 - 10 bar 13 bar | B | = 0 - 100 psi 140 psi | 2 | = 0 - 12 bar 15 bar | C | = 0 - 150 psi 190 psi | 3 | = 0 - 3 bar 6 bar | | | 4 | = 0 - 1 bar 2 bar | | | 5 | = 0 - 15 bar 18 bar | | | 6 | = 0 - 6 bar 9 bar | <p>Options</p> <p>A00 = Dual loop control 211 = Oxygen clean</p> <p>Display</p> <p>0 = without display 1 = with display</p> <p>Digital Output</p> <p>1 = Pressure switch output, PNP ± 5%</p> <p>Feedback</p> <p>1 = Feedback output 0 - 10 V 2 = Feedback output 0 - 20 mA 3 = Feedback output 4 - 20 mA 4 = Feedback input 0 - 10 Volt² 5 = Feedback input 0 - 20 mA² 6 = Feedback input 4 - 20 mA²</p> <p>Command Signal</p> <p>0 = 0 - 10 V 1 = 0 - 20 mA 2 = 4 - 20 mA</p> |
| | Max. Inlet Pressure | | Max Inlet Pressure | | | | | | | | | | | | | | | | | | | | | | | | | | |
| A | = 0 - 50 psi 90 psi | 1 | = 0 - 10 bar 13 bar | | | | | | | | | | | | | | | | | | | | | | | | | | |
| B | = 0 - 100 psi 140 psi | 2 | = 0 - 12 bar 15 bar | | | | | | | | | | | | | | | | | | | | | | | | | | |
| C | = 0 - 150 psi 190 psi | 3 | = 0 - 3 bar 6 bar | | | | | | | | | | | | | | | | | | | | | | | | | | |
| | | 4 | = 0 - 1 bar 2 bar | | | | | | | | | | | | | | | | | | | | | | | | | | |
| | | 5 | = 0 - 15 bar 18 bar | | | | | | | | | | | | | | | | | | | | | | | | | | |
| | | 6 | = 0 - 6 bar 9 bar | | | | | | | | | | | | | | | | | | | | | | | | | | |

Notes:
¹ See Accessories section for required manifold subbase.
² Feedback input is needed for dual loop units.

Sentronic^D

1/8 to 3/8 tapped body or 1/8 - 1/4 subbase mounted body (NPT or GTap)

- Sentronic^D is a highly dynamic 3-way proportional valve with digital control
- Sentronic^D stands for:
 - Digital communication and control
 - Display (integrated)
 - Direct operated valve
- A special feature of the Sentronic^D is its DaS software supplied for optimum adjustment via PC and viewing of command and feedback signals
- Other functions are valve diagnostics, parameter setting and maintenance
- Sentronic^D can be configured for dual loop control of process variables such as flow, force, speed, RPM and temperature



| Fluids | Ambient Temperature | Body | Internal Parts | Seals |
|--|------------------------------------|----------|------------------|---|
| Air or neutral gas, filtered at 50 µm, condensate-free, lubricated or unlubricated | 0 °C to 50 °C (32 °F to 122 °F) | Aluminum | POM (polyacetal) | NBR (nitrile) and FPM (fluoroelastomer) |

| General Valve Information | |
|--------------------------------|---|
| Fluid Temperature | 0 °C to 60 °C (32 °F to 140 °F) |
| Flow (Q _v at 6 bar) | 470 to 1300 l/min (ANR) |
| Command Signal | 0 – 10 V (impedance 100 kΩ), 0 – 20 mA, – 20 mA (impedance 250 Ω) |
| Ports | 1/8, 1/4, 3/8 (NPT or GTap) |
| Construction | Poppet Valve |
| Actuation | Proportional Solenoid |
| Hysteresis | < 1% of span |
| Linearity | < 0.5% of span |
| Repeatability | < 0.5% of span |
| Minimum Setpoint | 100 mV (0.2 mA/4.2mA) with shut-off function |
| Minimum Outlet Pressure | 1% of span |

| Electrical Characteristics | | | | | | |
|----------------------------|----------------|----------------|-------------------|------------------|----------------------|------------------------------------|
| Nominal Diameter DN (mm) | Voltage * | Max. Power (W) | Max. Current (mA) | Insulation Class | Degree of Protection | Electrical Connection |
| 4 | 24 VDC = ± 10% | 21 | 850 | H | IP65 | 5-pin M12 connector (not supplied) |
| 8 | 24 VDC = ± 10% | 40 | 1650 | H | IP65 | 5-pin M12 connector (not supplied) |

* Max. ripple: 10%

| Specifications | | | |
|----------------------|-------------------|--|------------------------|
| Ø Ports | Ø Orifice DN (mm) | Flow | |
| | | C _v Flow Factor (K _v Nm ² /h) | at 6 Bar (l/min - ANR) |
| 1/8, 1/4 NPT or GTap | 4 | 0.50 (0.43) | 470 |
| 1/4, 3/8 NPT or GTap | 8 | 1.39 (1.20) | 1300 |

Dimensions: inches (mm)

Inline version: DN 4

Weight: 0.56kg (1.23lbs)

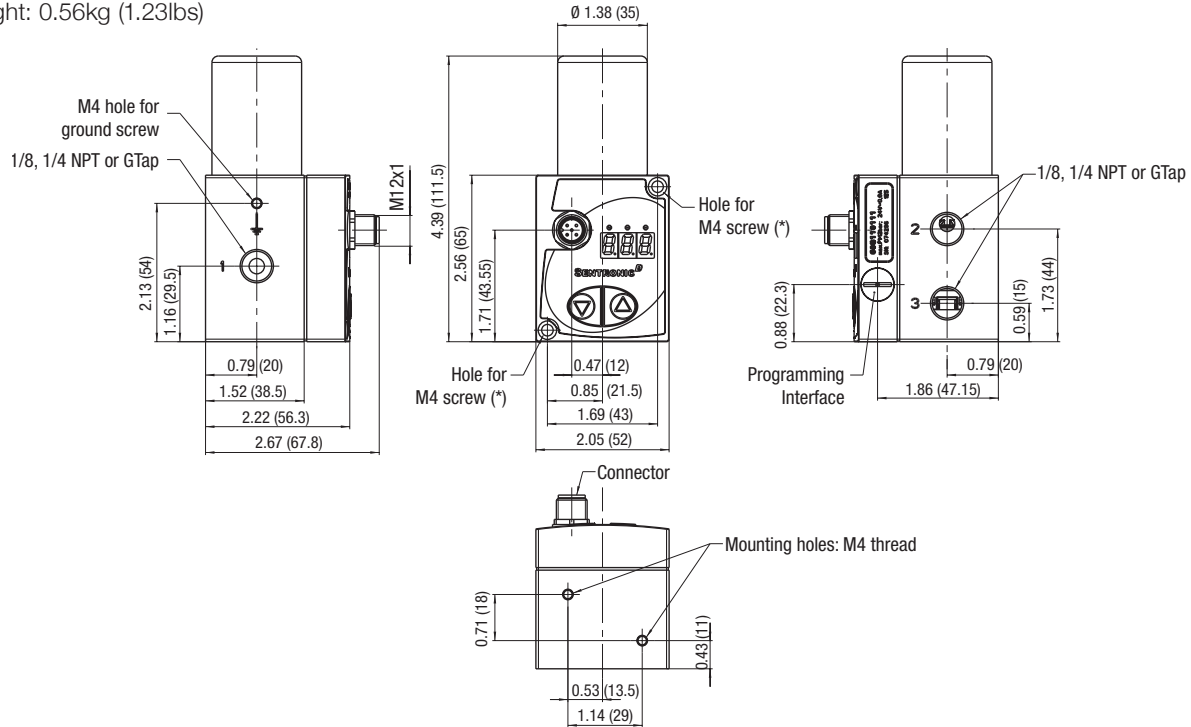

Inline version: DN 8

Weight: 1.13kg (2.49lbs)

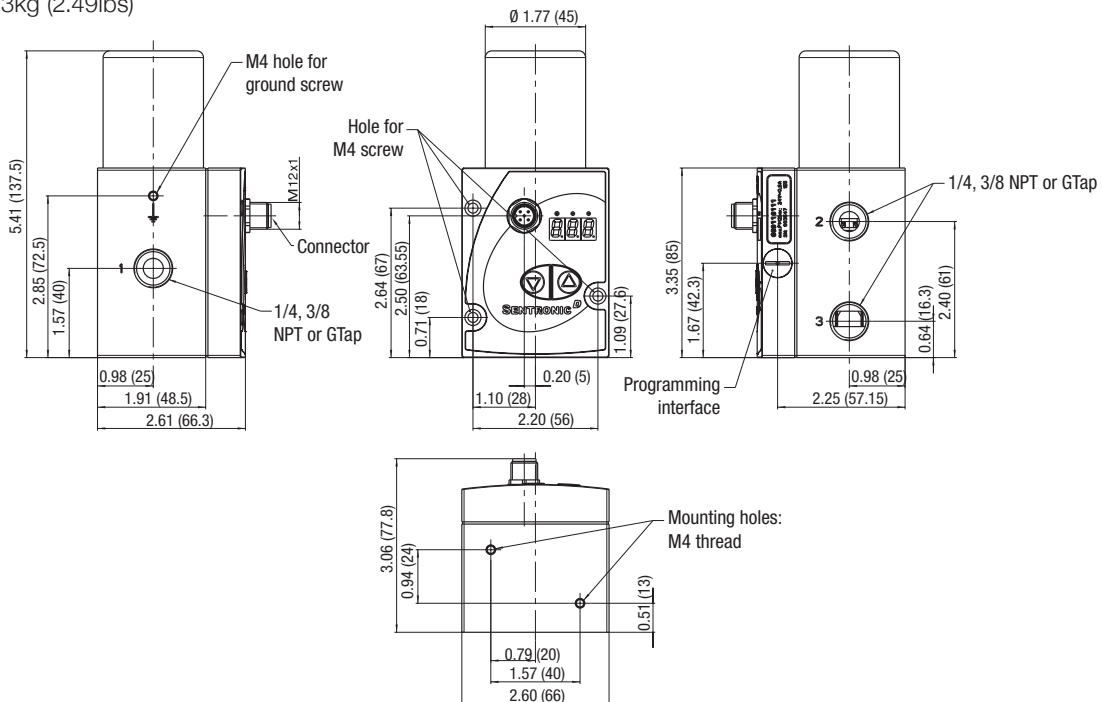

Dimensions: inches (mm)

Manifold version: DN 4

Weight: 0.56kg (1.23lbs)

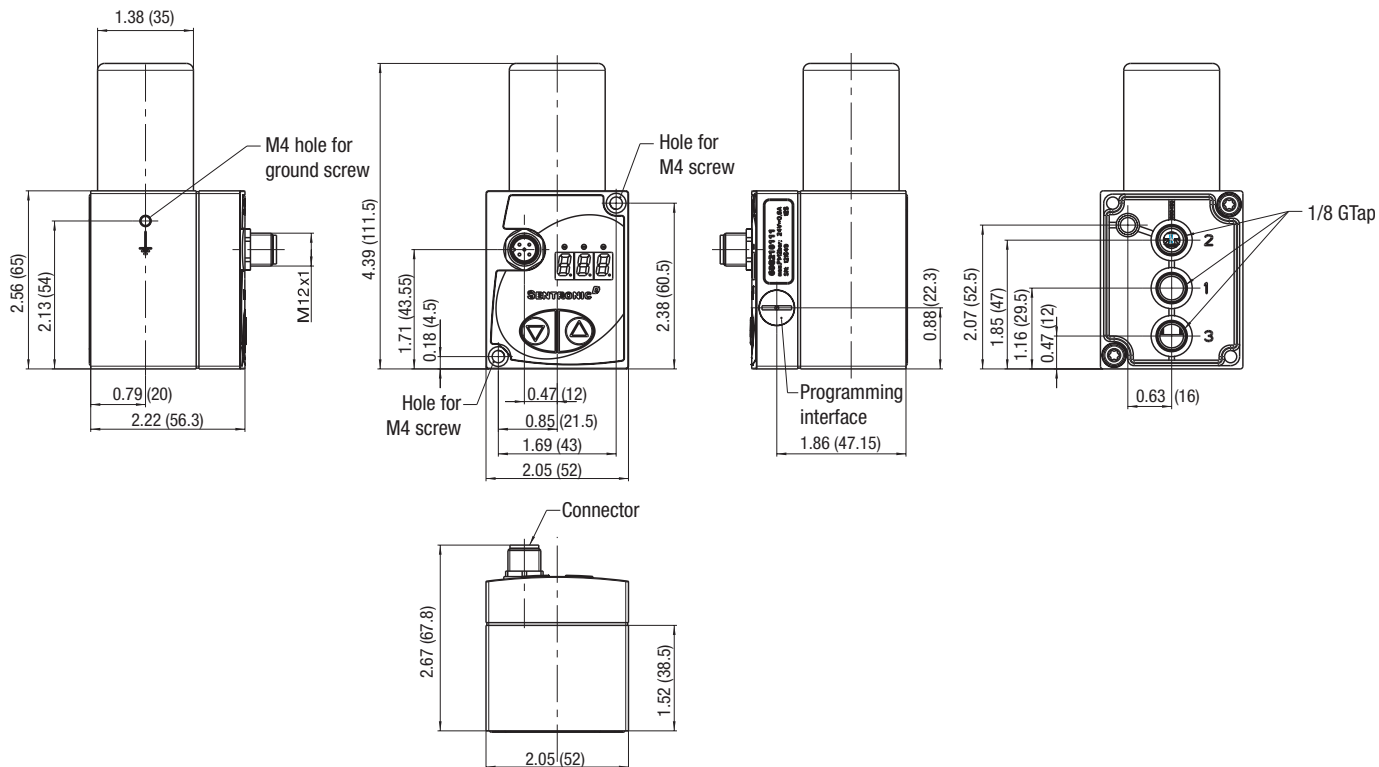

Manifold: DN 4

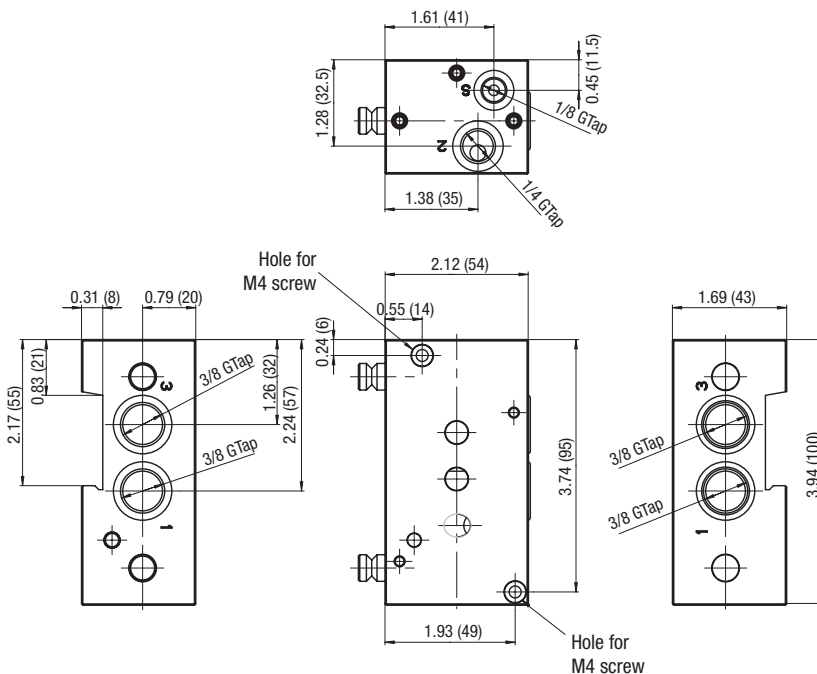

Dimensions: inches (mm)

Manifold version: DN 8

Weight: 1.13kg (2.49lbs)

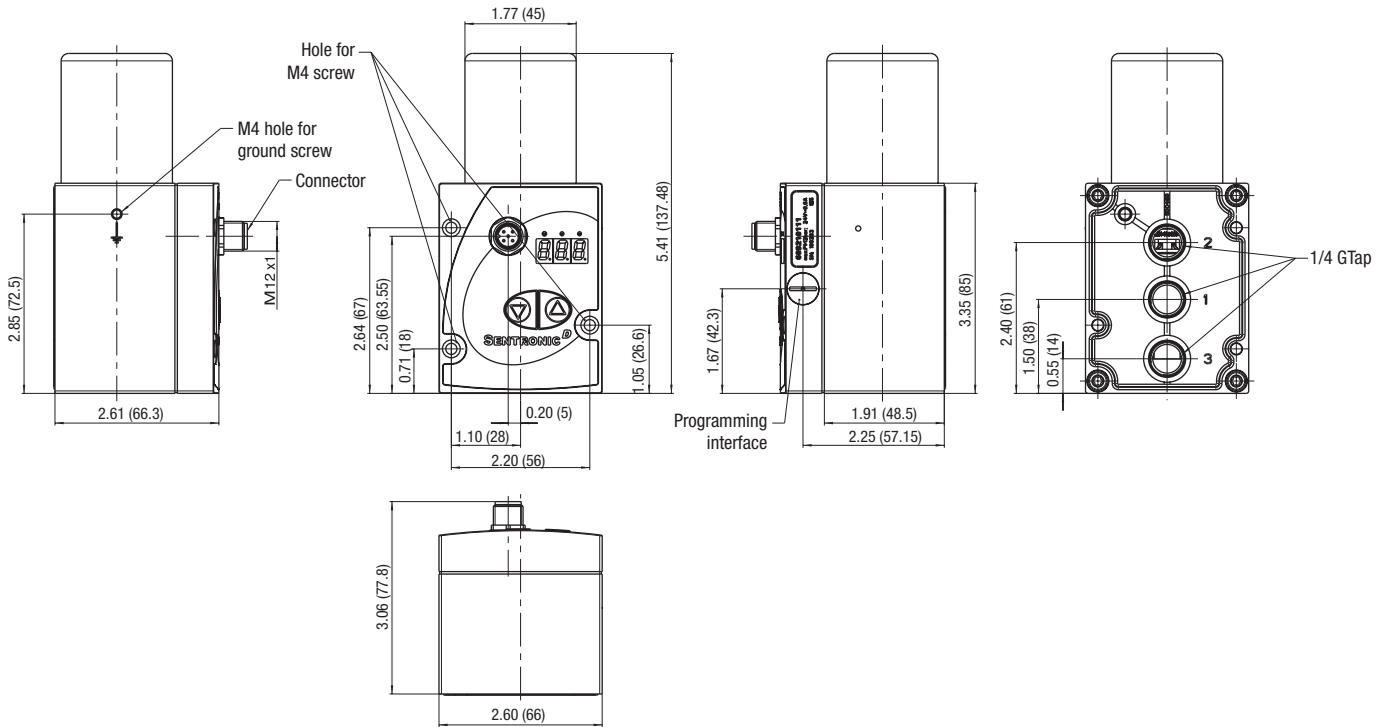

Manifold: DN 8

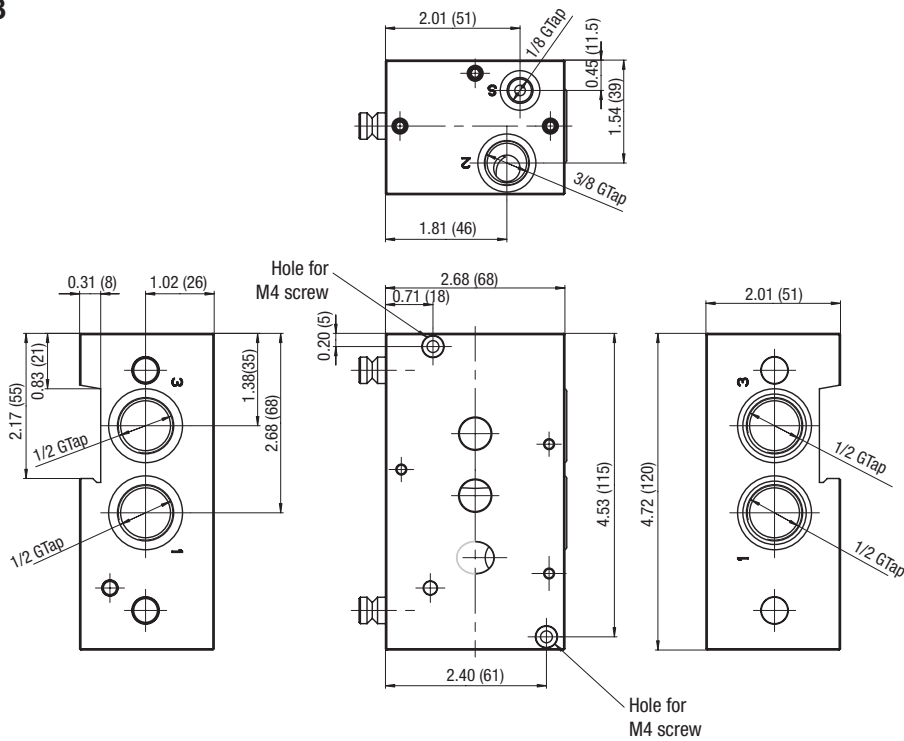

Connector Pin Out

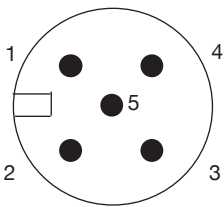

| Pin | Description |
|------|----------------------------------|
| 1 | +24 VDC Supply |
| 2 | Command Signal |
| 3 | +0 VDC Common (Supply) |
| | +0 VDC Common (Command Signal)* |
| 4 | Analog output (feedback) |
| 5 | Digital output (pressure switch) |
| Body | EMC shield |

* A 6-wire cable with separate common for the command signal is used for cable lengths over 2m to minimize the voltage drop for the command signal.

Accessories



| 5 Pin 12mm FEMALE Straight Field Attachable Connectors | | Model Number |
|---|--|---------------------|
| PG 9 Cable Gland | | TC05F20000000000 |

| 5 Pin 12mm FEMALE 90 DEGREE Field Attachable Connectors | | Model Number |
|--|--|---------------------|
| PG 9 Cable Gland | | TD05F20000000000 |

| Micro Female 5 Pole Straight 6 Wire 24 AWG, Shielded | | Model Number |
|---|--|---------------------|
| 3 Meter | | TC0503MMS000671Y |
| 5 Meter | | TC0505MMS000671Y |

| Micro Female 5 Pole 90 Degree 6 Wire 24 AWG Euro Color Code, Shielded | | Model Number |
|--|--|---------------------|
| 3 Meter | | TD0503MMS000671Y |
| 5 Meter | | TD0505MMS000671Y |

| Micro F/M 4 Pole Straight 22 AWG Euro Color Code | | |
|---|----------------------------|--|
| Unshielded | Shielded | |
| 2 Meter - TC0403MIETA04000 | 3 Meter - TC0403MMETA04000 | |
| 5 Meter - TC0405MIETA04000 | 5 Meter - TC0405MMETA04000 | |

| Micro F 90°/M Straight 22 AWG Euro Color Code | | |
|--|----------------------------|--|
| Unshielded | Shielded | |
| 2 Meter - TD0403MIETA04000 | 3 Meter - TD0403MMETA04000 | |
| 5 Meter - TD0405MIETA04000 | 5 Meter - TD0405MMETA04000 | |

| Manifold (individual subbases that join together) | Model Number |
|---|---------------------|
| Manifold for 608 (DN 4mm) with G3/8; supply/exhaust and G1/4 output | 35500558 |
| Manifold for 609 (DN 8mm) with G1/2; supply/exhaust and G3/8 output | 35500559 |

| PC Software & Cable Connectors | Model Number |
|--|---------------------|
| DaS Light: Data Acquisition Software for Sentronic ^D - basic parameters - free download at asco.com | 99100110 |
| DaS Expert: Data Acquisition Software for Sentronic ^D - full parameters | Consult Factory |
| RS 232 cable converter; 2m cable with 9-pin Sub-D (connector required for software usage) | 88100732 |

¹ Manifold ships with required hardware and gaskets for connecting manifolds together.

Sentronic^{PLUS}

Sentronic^{PLUS} is a digitally operated pressure regulator valve. This valve accurately adjusts pressure, flow, force, speed, and linear or angular positions. All orifices have the same diameter for short response times whether increasing or exhausting pressure. The valve components are designed to provide control at an extremely low hysteresis.

Sentronic^{PLUS} regulates pressure up to 725 psi (50 bar) and can be used in potentially explosive atmospheres according to ATEX Directive 94/9/EC.

With the Data Acquisition Software (DaS) and the RS232 interface, it is now possible to optimally adjust the valve's control parameters to a specific application. The scope function allows you to log and read out the system's response in real time.

The DaS capabilities streamline the development process and identify application-specific problems at an early stage. Saved control parameters can be loaded at any time and used as a reference for maintenance and error detection. Saved parameters can also be used for future production so that valves are factory-set to a specific application.

Actuating Solenoid

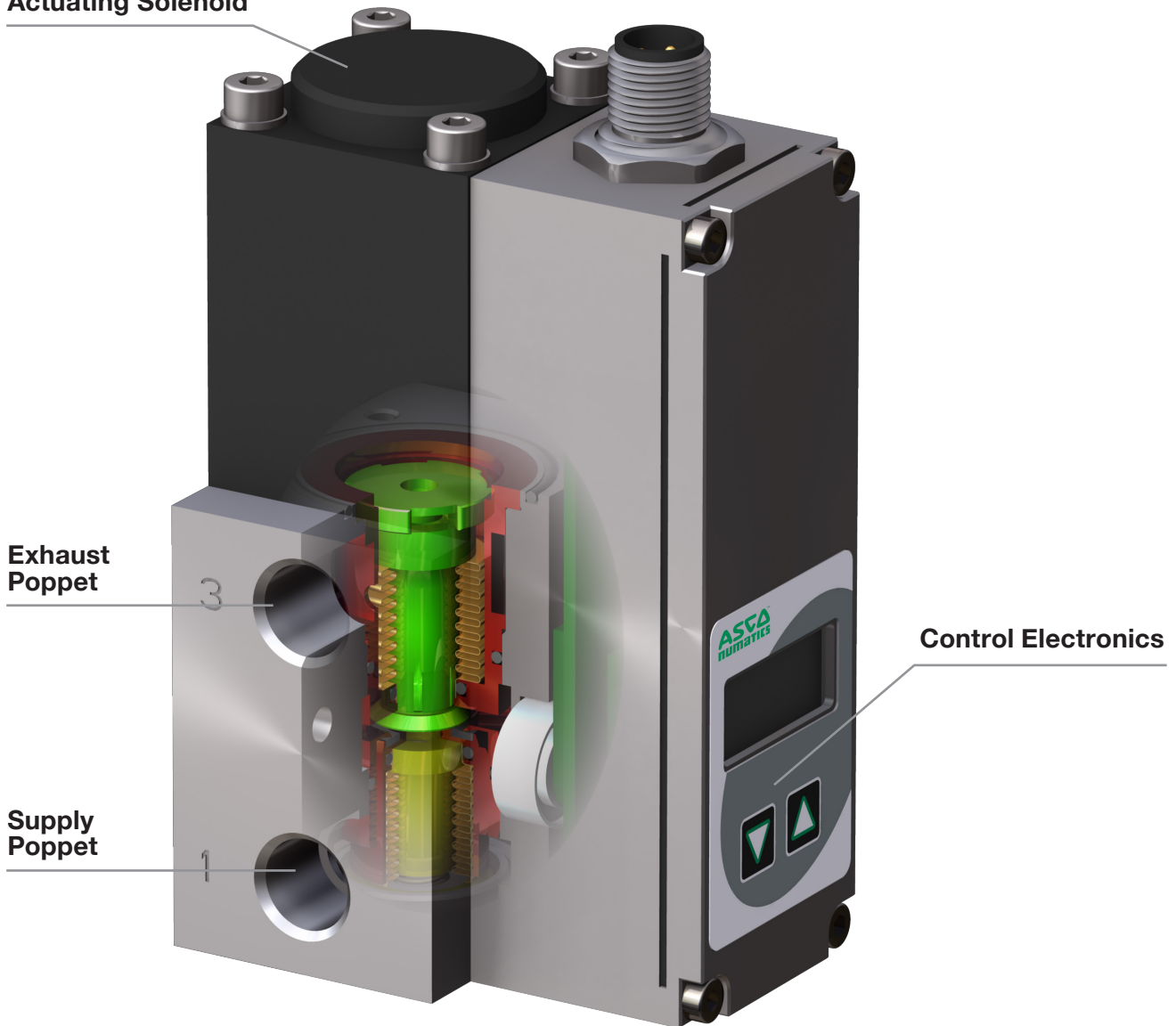

Exhaust Poppet
3

Supply Poppet
1

Control Electronics

All Sentronic valves are tested before leaving our manufacturing facilities. Each valve is provided with a test certificate showing all the test results.



Advantages

- Minimum hysteresis
- Quick response times
- Very high sensitivity
- Standard 50 µm filtration
- No constant air consumption
- Analog command signal
- Analog feedback output
- PC communication
- Digital Control
- Easy change of control parameters

Vacuum Control Options

Sentronic valves can be used for applications where pressure and vacuum control is required. For instance, for testing the strength of piping, for testing car brake amplifiers, etc.

3 versions are available:

V1 "Shut-off" version

The valve is connected between the vacuum pump and the system to be regulated as shown in the diagram below. As long as the level of vacuum is not reached, the Sentronic^{PLUS} valve allows free flow between the pump and the load system. When the setpoint is reached, the valve closes the circuit and no more air is consumed. In the event of leakage of the load system, the valve provides regulation by reconnecting the volume to the vacuum pump. When the setpoint is switched off, the valve breaks the vacuum by connecting the volume to atmosphere. When the 24 VDC is switched off, the valve connects the outlet to maximum vacuum.

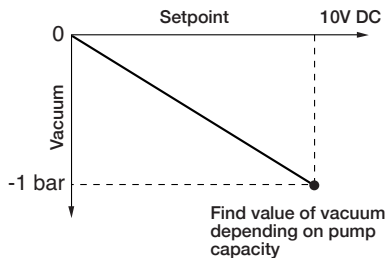
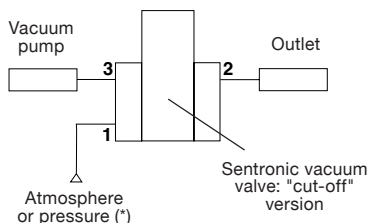

V2 "By-pass" version

The vacuum pump operates continuously and the Sentronic^{PLUS} is installed in a branch to regulate the level of the vacuum in the load system as a function of the setpoint by allowing a variable rate of air at atmospheric pressure to enter the system.

In this case, port 3 must be plugged.

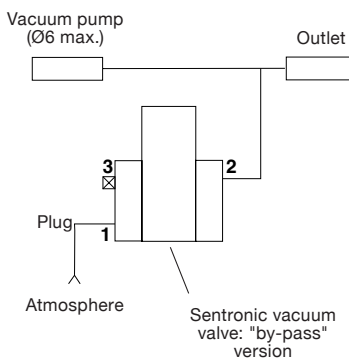

*To accelerate vacuum control, it is possible to apply pressure (max. 2 bar) instead of atmospheric pressure to port 1 in the V1 Shut-off version or to port 3 in the V3 Shut-off version

Operating Principle

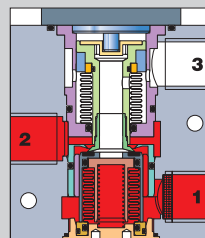

Increasing Pressure
The pressurization piston is operated and the flow from port 1 to port 2 is released.

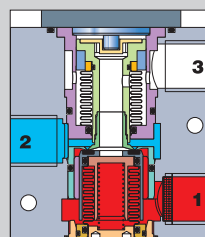

Exhausting Pressure
The exhaust piston is lifted and the flow from port 3 to port 2 is released.

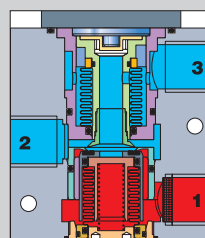

Maintaining Pressure
The exhaust piston is in its central position: the flow between port 2 and port 1 or port 3 is blocked.

V3 "Shut-off" version

Version V3 has the same function as version V1, but connects the outlet to atmosphere on loss of power. There is no current to the proportional coil when zero vacuum is commanded.

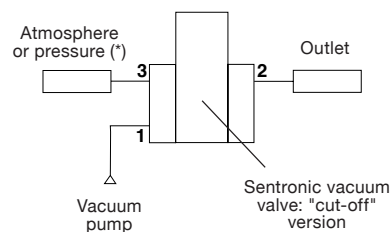

How to Order

6 1 4 3 5 7 E 9 0 1 1 PB

Control Panel

- D = M12 with display - non-explosionproof
- E = M12 without display - explosionproof (ATEX)
- F = DIN connector, 7-pin, with display - non-explosionproof¹
- G = DIN connector, 7-pin without display - non-explosionproof¹

Version (ports), Body

- 0 = DN6 (G 1/4), ALU
- 1 = DN12 (G 1/2), ALU²
- 2 = DN20 (G 1), ALU²
- 4 = DN6 (NPT 1/4), ALU
- 5 = DN12 (NPT 1/2), ALU²
- 6 = DN20 (NPT 1), ALU²
- 7 = DN3 (G 1/8), Brass
- 8 = DN6 (G 1/4), Brass
- 9 = DN3 (NPT 1/8), Brass
- A = DN6 (NPT 1/4), Brass
- C = DN6 (G 1/4), Stainless Steel
- G = DN6 (NPT 1/4), Brass³
- H = DN6 (G 1/4), Brass
- J = DNI (G 1/4), Brass³
- K = DNI (NPT 1/4), Brass

Command Signal

- 0 = 0 – 10 V
- 1 = 0 – 20 mA
- 2 = 4 – 20 mA

Feedback

- 1 = Feedback output 0 – 10 Volt
- 2 = Feedback output 0 – 20 mA
- 3 = Feedback output 4 – 20 mA
- 4 = Feedback input 0 – 10 Volt⁴
- 5 = Feedback input 0 – 20 mA⁴
- 6 = Feedback input 4 – 20 mA⁴

Options

- A00 = Dual loop control
- 018 = Oxygen clean

Pressure Range

Output Pressure (psi)

- 40 = 0 – 0.1 bar (1.5)
- 50 = 0 – 0.5 bar (7.3)
- 60 = 0 – 1 bar (14.5)
- 02 = 0 – 2 bar (29)
- 03 = 0 – 3 bar (44)
- PA = 0 – 3.4 bar (50)
- 05 = 0 – 5 bar (73)
- 06 = 0 – 6 bar (87)
- PB = 0 – 6.9 bar (100)
- 10 = 0 – 10 bar (145)
- PC = 0 – 10.3 bar (150)
- 12 = 0 – 12 bar (174)
- PD = 0 – 12.8 bar⁵ (200)
- 16 = 0 – 16 bar⁵ (232)
- PE = 0 – 17.2 bar⁵ (250)
- 20 = 0 – 20 bar⁵ (290)
- PF = 0 – 20.7 bar⁵ (350)
- 3H = 0 – 30 bar⁶ (435)
- 5H = 0 – 50 bar⁶ (725)

Max. Inlet Pressure (psi)

- 2 (29)
- 2 (29)
- 2 (29)
- 3 (44)
- 8 (116)
- 8 (116)
- 8 (116)
- 12 (174)
- 12 (174)
- 12 (174)
- 12 (174)
- 14 (203)
- 18 (261)
- 18 (261)
- 22 (316)
- 22 (316)
- 22 (316)
- 40 (580)
- 60 (870)

Vacuum (relative)

- V1 = 0 to -1 bar Shut-off valve, connects to vacuum on loss of power
- V2 = 0 to -1 bar Bypass valve
- V3 = 0 to -1 bar Shut-off valve, connects to atmosphere on loss of power

Absolute Pressure Ranges Available on Request

Digital Output

- 1 = Pressure switch output PNP ± 5%

¹ 7-pin DIN connector allows crossover from 833-354 or 601 Series legacy analog Sentronic version; ships with field installable connector.

² Up to max. 12 bar ³ Only for pressure ranges from 30 to 50 bar ⁴ Feedback input is needed for dual loop units

⁵ Only for DN1, DN3 & DN6 ⁶ Only for DN6 body type G or H. Other versions available on request.

Sentronic^{PLUS} Electronic Pressure Regulator

Sentronic^{PLUS} is a 3-way proportional valve with digital control. Its construction allows the valve to be used in potentially explosive atmospheres according to ATEX Directive 94/9/EC. The valve also has pressure ranges from 1.5 psi to 725 psi. The Data Acquisition Software (DaS) that comes with Sentronic^{PLUS} can be used to adjust the valve's control parameters to a specific application. Command signal, feedback signal and control parameters can be viewed in real time and adjusted as required for an application. Settings can be saved and loaded at any time for reference or diagnostics. Sentronic^{PLUS} can be configured for dual loop control of process variables such as flow, force, speed, RPM, and temperature.

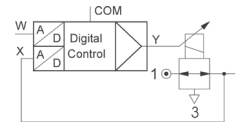

| Fluids | Ambient Temperature | Body | Internal Parts | Seals |
|--|---------------------------------|----------|---------------------------|---|
| Air or neutral gas, filtered at 50 µm, condensate-free, lubricated or unlubricated | 0 °C to 60 °C (32 °F to 140 °F) | Aluminum | Stainless steel and brass | NBR (nitrile) and FPM (fluoroelastomer) |

| General Valve Information | |
|--|--|
| Fluid Temperature | 0 °C to 60 °C (32 °F to 140 °F) |
| Command Signal- analog | 0 – 10 V (impedance 100 KΩ), 0 - 20 mA/4 - 20 mA (impedance 250 Ω) |
| Ports | 1/8, 1/4, 3/8 (NPT or GTap) |
| Construction | Direct-operated Poppet Valve |
| Hysteresis | 1% of span |
| Linearity/ pressure measurement | ± 0.5% of span |
| Repeatability | ± 0.5% of span |
| Explosion Safety | |
| Safety code | Ⓔ II 2D Ex tb IIIC T135°C Db, Ⓔ II 3G Ex nA IIC T4 Gc, 0 ≤ Ta ≤ 50°C |
| EC type examination certificate number | IBExU07ATEX1173 |

| Electrical Characteristics | | | | | | |
|----------------------------|--------------|-----------------|-------------------|------------------|----------------------|--|
| Nominal Diameter DN (mm) | Voltage * | Max. Power (W) | Max. Current (mA) | Insulation Class | Degree of Protection | Electrical Connection |
| 1 | 24 VDC ± 10% | 12 | 500 | F | IP65 | 5-pin M12 connector or 7-pin DIN connector |
| 3 | 24 VDC ± 10% | 12 | 500 | F | IP65 | 5-pin M12 connector or 7-pin DIN connector |
| 6 | 24 VDC ± 10% | 24 ¹ | 1000 ¹ | F | IP65 | 5-pin M12 connector or 7-pin DIN connector |
| 12 | 24 VDC ± 10% | 34 | 1400 | F | IP65 | 5-pin M12 connector or 7-pin DIN connector |
| 20 | 24 VDC ± 10% | 44 | 1800 | F | IP65 | 5-pin M12 connector or 7-pin DIN connector |

* Max. ripple: 10%

¹ For DN6, brass version G or H/1.8A, 44W

| Specifications | | | | |
|-----------------|-------------------|--|------------------------|--|
| Ø Ports | Ø Orifice DN (mm) | Flow | | |
| | | C _v Flow Factor (K _v Nm ² /h) | at 6 Bar (l/min - ANR) | |
| 1/8 NPT or GTap | 1 | 0.032 (0.028) | 30 | |
| 1/8 NPT or GTap | 3 | 0.21 (0.18) | 210 | |
| 1/4 NPT or GTap | 6 | 0.70 (0.60) | 700 | |
| 1/2 NPT or GTap | 12 | 1.39 (1.20) | 1400 | |
| 1 NPT or GTap | 20 | 5.57 (4.80) | 5600 | |

Dimensions: inches (mm)

1/8 NPT or GTap (DN1 and DN3)

Weight: 0.55kg (1.21lbs)

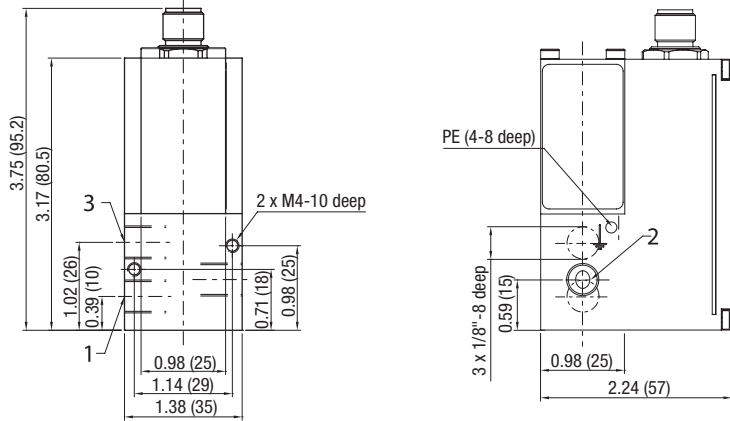

1/4 NPT or GTap

Weight: 0.85kg (1.87lbs)

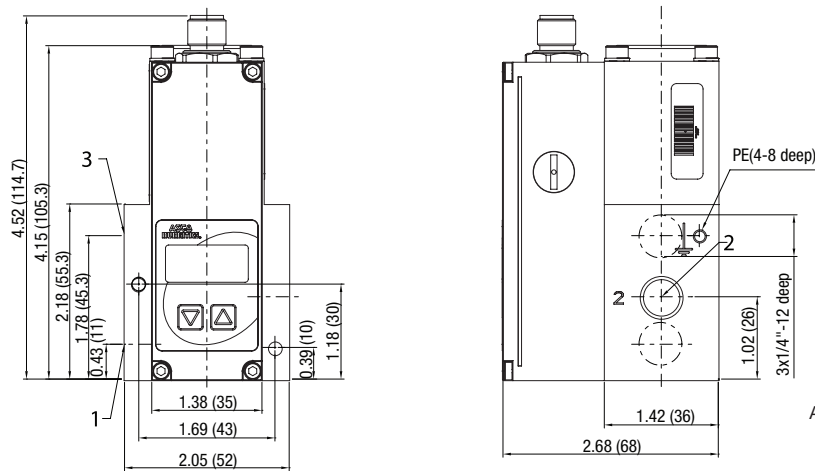

A) Thread M5 - depth 10
(on opposite side); tapped
through-hole for M4 screw.

1/2 NPT or GTap

Weight: 1.65kg (3.64lbs)

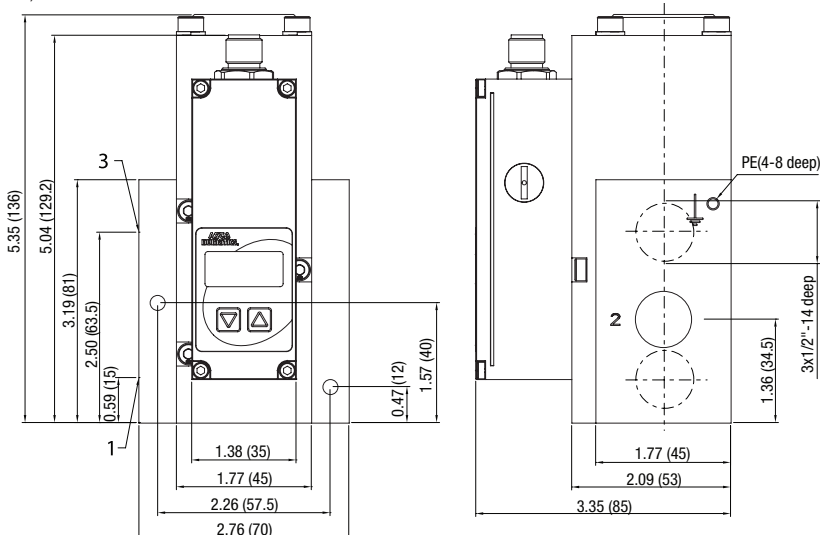

A) Thread M5 - depth 10
(on opposite side); tapped
through-hole for M4 screw.

Dimensions: inches (mm)

1 NPT or GTap

Weight: 3.40kg (7.50lbs)

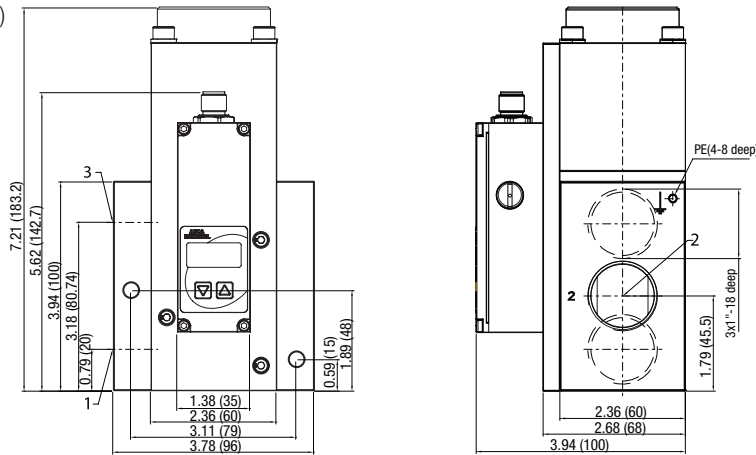

A) Thread M8 - depth 15
(on opposite side); tapped
through-hole for M6 screw.

Connector Pin Out

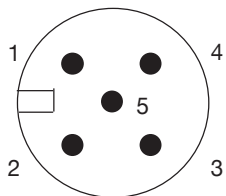

| Pin | Description |
|------|----------------------------------|
| 1 | +24 VDC Supply |
| 2 | Command Signal |
| 3 | +0 VDC Common (Supply) |
| | +0 VDC Common (Command Signal)* |
| 4 | Analog output (Feedback) |
| 5 | Digital output (Pressure switch) |
| Body | EMV screen |

* A 6-wire cable with separate common for the command signal is used for cable lengths over 2m to minimize the voltage drop for the command signal.

Accessories



| 5 Pin 12mm FEMALE Straight Field Attachable Connectors | | Model Number |
|--|--|-------------------|
| PG 9 Cable Gland | | TC05F20000000000 |
| 5 Pin 12mm FEMALE 90 DEGREE Field Attachable Connectors | | Model Number |
| PG 9 Cable Gland | | TD05F20000000000 |
| Micro Female 5 Pole Straight 6 Wire 24 AWG, Shielded | | Model Number |
| 3 Meter | | TC0503MMS000671Y |
| 5 Meter | | TC0505MMS000671Y |
| Micro Female 5 Pole 90 Degree 6 Wire 24 AWG Euro Color Code, Shielded | | Model Number |
| 3 Meter* | | TD0503MMS000671Y* |
| 5 Meter* | | TD0505MMS000671Y* |
| PC Software & Cable Connectors | | Model Number |
| DaS Light: Data Acquisition Software for Sentronic ^D - basic parameters - free download at asco.com | | 99100110 |
| DaS Expert: Data Acquisition Software for Sentronic ^D - full parameters | | Consult Factory |
| RS 232 cable converter; 2m cable with 9-pin Sub-D (connector required for software usage) | | 88100732 |

* Do not use with the 1" Sentronic^{PLUS}

Sentronic^{HD}

Sentronic^{HD} is a highly accurate three-way proportional valve with digital control and a broad range of diagnostic functions. It is supplied with DaS HD software which can be used with a PC for optimal calibration of the valve.

- Control which is stable under pressure
- Control deviation < 0.25%
- Comprehensive diagnostic functions
- Minimal heating of device
- Industry 4.0 ready
- Integrated web server
- Minimal power consumption (< 5 Watt)

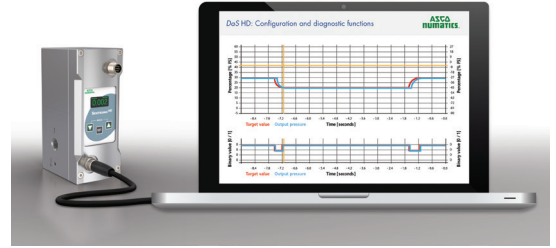

M12 Connection:
Power Supply
Target/Actual Value/Input/Output
Frequency Input

Digital Display

Adjustment Buttons

Ethernet TCP/IP:
Programming Interface

**Proportional
Pilot Valve**

Exhaust:
G1/4 Connection

Output:
G1/4 Connection



Sentronic^{HD} Electronic Pressure Regulator

Sentronic^{HD} is a 3-way proportional valve with digital control. The Data Acquisition Software (DaS) that comes with Sentronic^{HD} can be used to adjust the valve's control parameters to a specific application. Command signal, feedback signal and control parameters can be viewed in real time and adjusted as required for an application. Sentronic^{HD} can be configured for dual loop control of process variables such as flow, force, speed, RPM, and temperature.

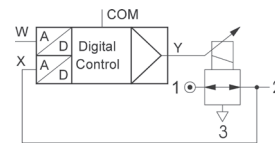

| Fluids | Ambient Temperature | Body | Internal Parts | Seals |
|--|---------------------------------|----------|--|-----------------------|
| Air or neutral gas, condensate-free, lubricated or unlubricated, Class 5 to ISO 8573-1 | 0 °C to 50 °C (32 °F to 122 °F) | Aluminum | Stainless steel, brass, aluminum & POM | FPM (fluoroelastomer) |

| General Valve Information | |
|----------------------------------|---------------------------------|
| Maximum allowable pressure (MAP) | 174 psi (12 bar) |
| Fluid Temperature | 0 °C to 50 °C (32 °F to 122 °F) |
| Ports | G1/4 |
| Construction | Pilot-operated Valve |
| Hysteresis | ± 0.25% of span |
| Linearity | ± 0.25% of span |
| Repeatability | ± 0.25% of span |

| Electrical Characteristics | | | | | | |
|----------------------------|----------------|----------------|-------------------|------------------|----------------------|---|
| Nominal Diameter DN (mm) | Voltage * | Max. Power (W) | Max. Current (mA) | Insulation Class | Degree of Protection | Electrical Connection |
| 6 | 24 VDC = ± 10% | 5 | 240 | F | IP65 | 8-pin M12 connector, A coded (not supplied) |

* Max. ripple: 10%

| Specifications | | | |
|----------------|-------------------|--|------------------------|
| Ø Ports | Ø Orifice DN (mm) | Flow | |
| | | C _v Flow Factor (K _v , Nm ³ /h) | at 6 Bar (l/min - ANR) |
| G 1/4 | 6 | 1.30 (1.12) | 1200 |

How to Order

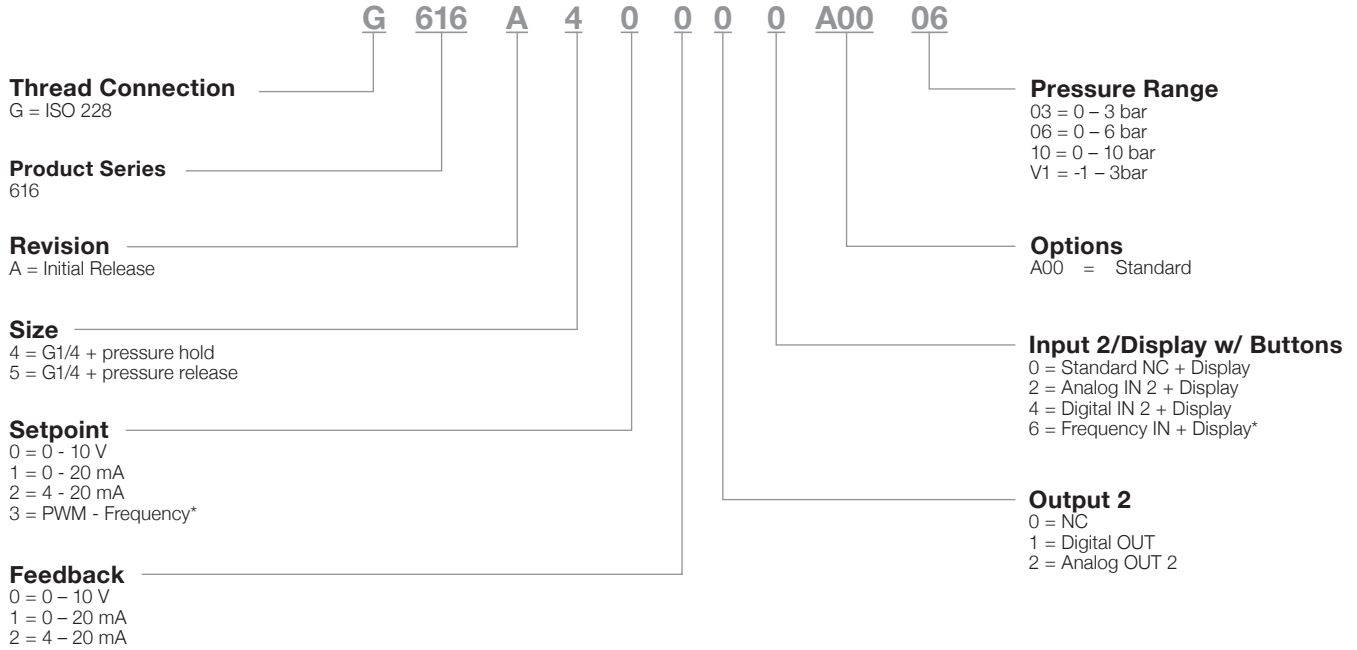

* If Setpoint PMW-Frequency is selected, frequency input is not available at IN 2

Dimensions: mm (inches)

Weight: 1.6kg (3.53lbs)

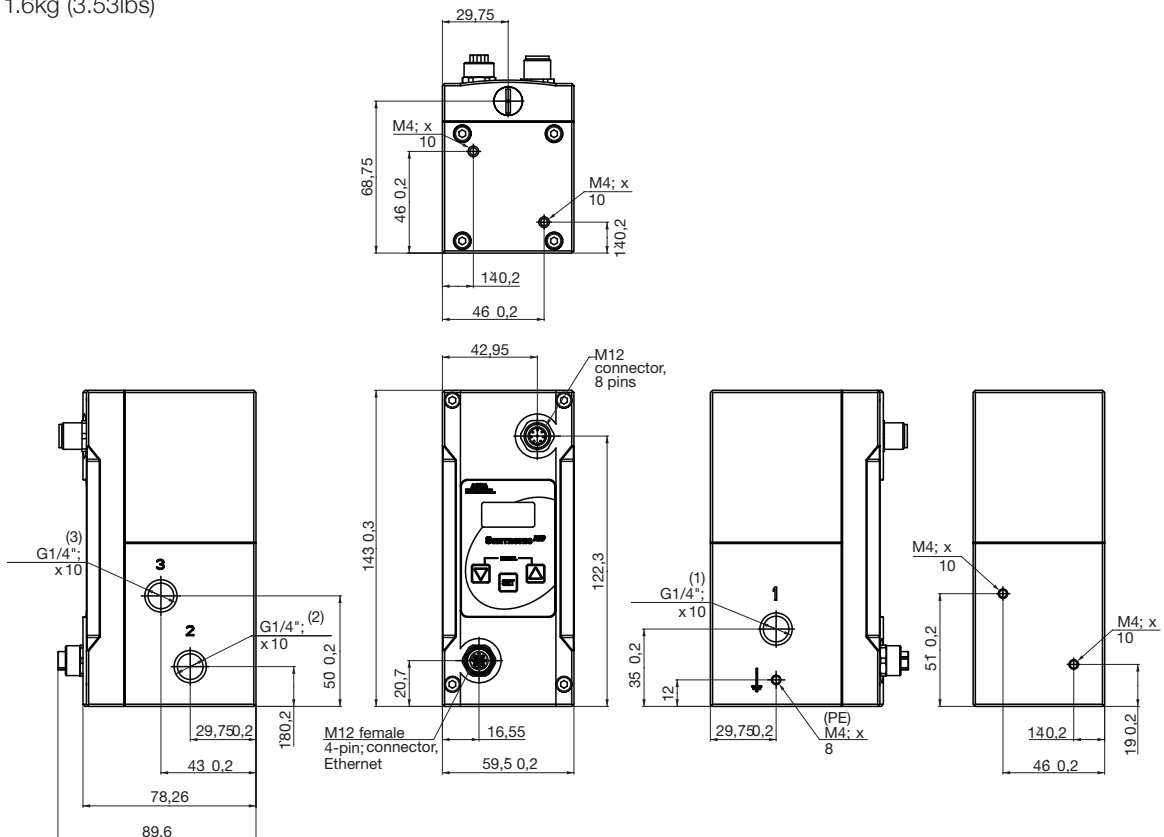

Connector Pinning/Cable Wiring

Ethernet IP programming interface

M12 male connector,
4-pin, D coded

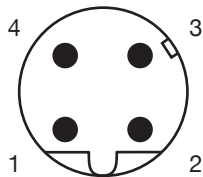

View on male connector (the device is equipped with a female connector)

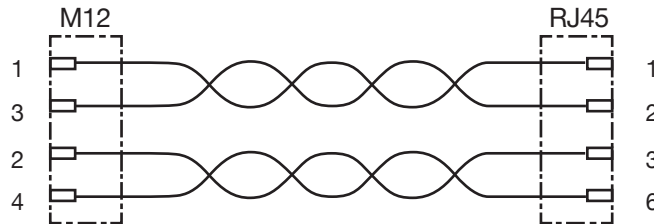

The use of a shielded cable is recommended.

M12 male connector,
8-pin, A coded

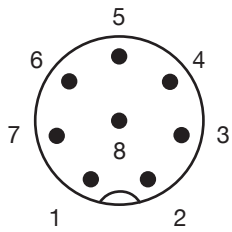

View on valve

| Pin | Description | 8-wire cable (5m, 10m) |
|------|--|------------------------|
| 1 | Digital Input | white |
| 2 | 24 VDC voltage supply | brown |
| 3 | Setpoint ground SET- | green |
| 4 | Setpoint SET+ (PWM) | yellow |
| 5 | Analog input 2/Digital input 2/Frequency input | gray |
| 6 | Analog output | pink |
| 7 | Ground 24 VDC | blue |
| 8 | Digital output/Analog output 2 | red |
| Body | EMC screen | shield |

Accessories

| Description | Catalog Number |
|--|------------------|
| Supply cable 5m; 8 x 0.50mm ² ; straight connector | TC0805MQX0000000 |
| Supply cable 10m; 8 x 0.50mm ² ; straight connector | TC0810MQX0000000 |
| Supply cable 10m; 8 x 0.50mm ² ; right-angle connector | TD0810MQX0000000 |
| Programming cable 5m; M12 Straight 4 Pin Male D-Coded to Male RJ45 | QA0405MK0VA04000 |

Sentronic^{LP}

The Sentronic^{LP} is a highly efficient and cost-effective option for your pressure regulation requirements.

Offering a small footprint, an easy to use and modular design, and advanced software capabilities, the Sentronic^{LP} and the full Sentronic range offers unrivaled value and product versatility to optimize your process, whatever the application requirements.

- Low power consumption (< 4 Watt) due to pilot controlled system
- A versatile, compact and lightweight design
- Intelligent digital communication and simple operation
- Pressure remains stable under flow conditions
- Holds pressure on loss of power
- Excellent value option

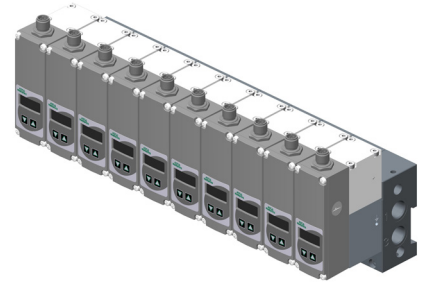

The Manifold Version

- Space saving design
- Only one pressure supply is needed, allowing for economic, simple and quick installation
- Offers the highest capabilities on the market – can hold up to 10 valves

**M12 Connection:
Power Supply
Target/Actual Value**

Pressure Supply

Digital Display

Adjustment Buttons



**Output:
1/4 , 3/8 or 1/2 Connection**

**Protective Ground
Connection: M4**

Mounting

**Exhaust:
1/4 , 3/8 or 1/2 Connection**

Sentronic^{LP} Electronic Pressure Regulator

1/4 to 1/2 tapped body or subbase mounted body

Sentronic^{LP} is a low power, pilot operated electronic proportional valve. Like the entire Sentronic product line, performance can be modified as needed for specific applications using the free ASCO DaS setup software (USB interface cable required).



| Fluids | Ambient Temperature | Body | Internal Parts | Seals |
|---|---------------------------------|----------|------------------|---------------|
| Air or neutral gas, filtered at 50 µm condensate-free, lubricated or unlubricated, class 5 according to ISO 8573-1:2010 [7:4:4] | 0 °C to 50 °C (32 °F to 122 °F) | Aluminum | POM (polyacetal) | NBR (nitrile) |

| General Valve Information | |
|---------------------------|--|
| Fluid Temperature | 0 °C to 60 °C (32 °F to 140 °F) |
| Minimum Required Pressure | At least 15 psi above the maximum outlet pressure |
| Pressure Range | 0 – 50 psi, 0 – 100 psi, 0 – 150 psi |
| Setpoint | 0 – 10 V (Impedance 100 kΩ), 0 – 20 mA/4 – 20 mA (Impedance 250 Ω) |
| Hysteresis | 1% of span |
| Linearity | 1% of span |
| Repeatability | 1% of span |
| Minimum Setpoint | 100 mV (0.2 mA/4.2mA) with shut-off function |
| Minimum Outlet Pressure | 1% of span |
| Failsafe Behavior | Pressure hold on loss of power, without control |

| Electrical Characteristics | | | | | | |
|----------------------------|----------------|---------------------------|-------------------|------------------|----------------------|------------------------------------|
| Nominal Diameter DN (mm) | Voltage * | Max. Power (W) | Max. Current (mA) | Insulation Class | Degree of Protection | Electrical Connection |
| 4, 8, 15 | 24 VDC = ± 10% | 3.8 W (< 1 W at pressure) | 160 | H | IP65 | 5-pin M12 connector (not supplied) |

* Max. ripple: 10%

| Specifications | | | | |
|---------------------|-------------------|--|------------------------|--|
| Ø Ports NPT or BSPP | Ø Orifice DN (mm) | Flow | | |
| | | C _v Flow Factor (K _v Nm ³ /h) | at 6 Bar (l/min - ANR) | |
| 1/4 | 4 | 0.50 (0.43) | 470 | |
| 3/8 | 8 | 1.39 (1.20) | 1300 | |
| 1/2 | 15 | 5.57 (4.80) | 5200 | |

How to Order

8 617 A 4 2 2 1 0 A00 PB

Threaded Connection

G = ISO 228 (BSPP)
8 = NPT

Product Series

617

Revision

A = Initial release

Size

0 = Manifold Version + pressure hold (DN4)¹
4 = 1/4 + pressure hold (DN4)
6 = 3/8 + pressure hold (DN8)
8 = 1/2 + pressure hold (DN15)

Setpoint

0 = 0 – 10 V
1 = 0 – 20 mA
2 = 4 – 20 mA
5 = 2 Bit, 4 pressure select

Pressure Range

Max. Inlet Pressure

PA = 0 – 50 psi 90 psi
PB = 0 – 100 psi 140 psi
PC = 0 – 150 psi 190 psi

Options

A00 = Standard
A07 = Oxygen clean

Input/Display w/Buttons

0 = Standard not connected + Display
1 = Standard not connected
8 = Digital IN + Display

Output 2

0 = Not connected
1 = Digital OUT² (Standard)

FeedbackType

0 = 0 – 10 V
1 = 0 – 20 mA
2 = 4 – 20 mA
7 = 2 Bit, 4 pressure select

¹ See Accessories for individual subbases for this Manifold Version
² No Digital In possible

Dimensions: mm (inches)

DN 4
Inline version

Weight: 0.49kg (1.08lbs)

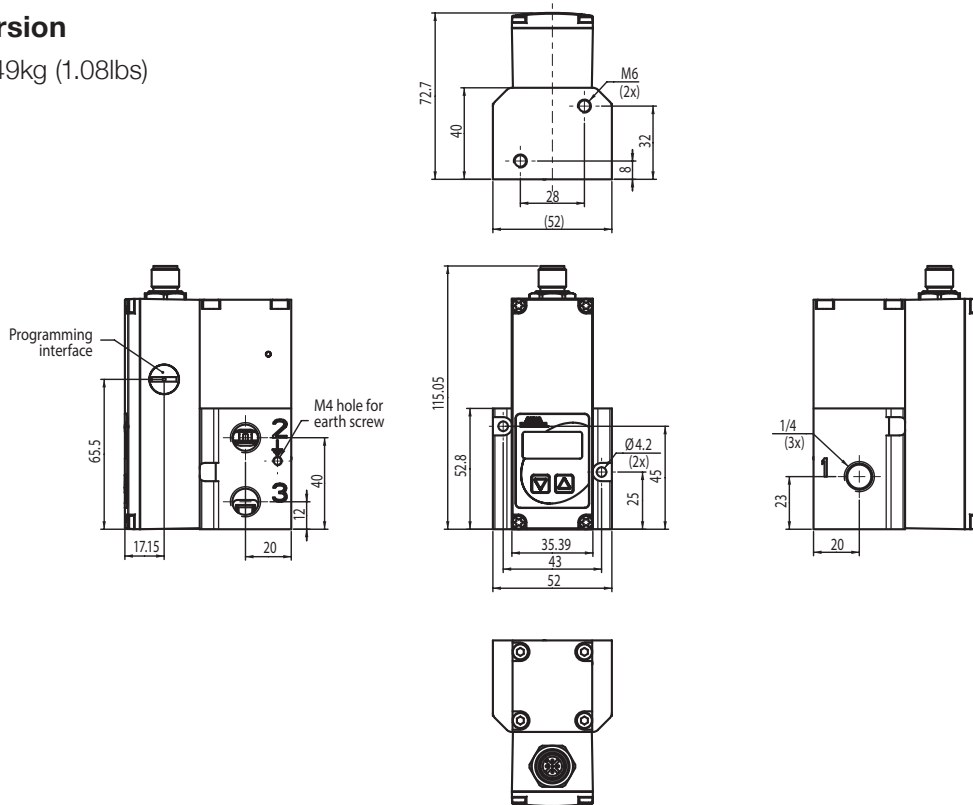

Dimensions: mm

DN 4

Subbase version

Weight: 0.49kg (1.08lbs)

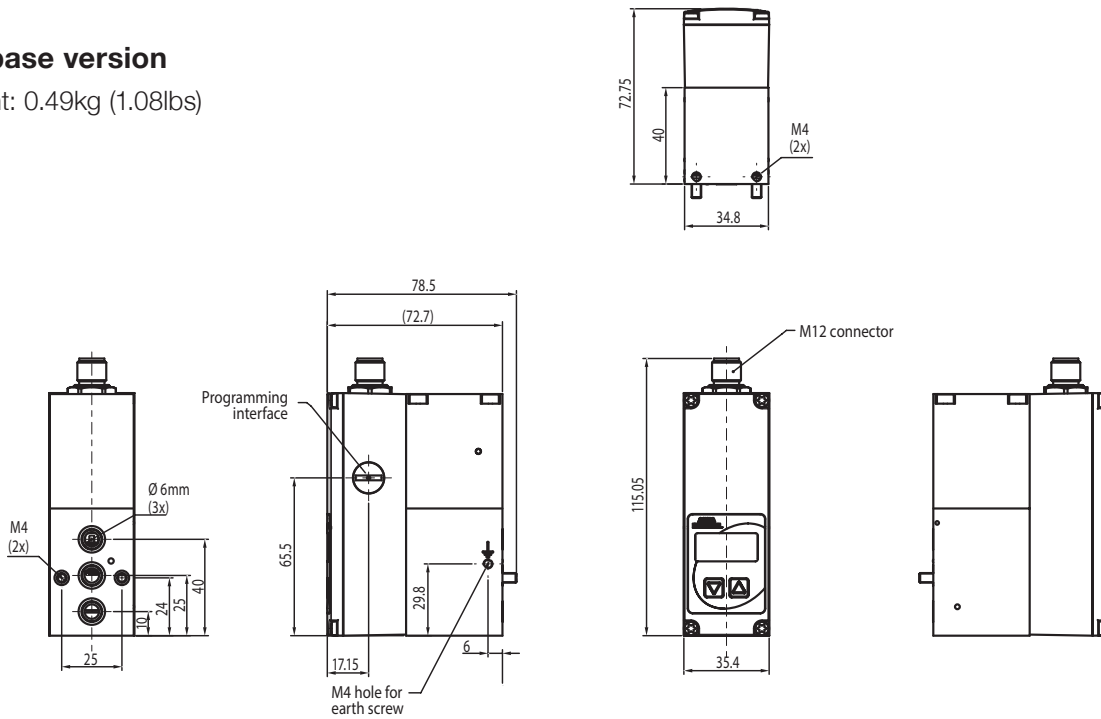

DN 4

Joinable subbase

Weight: 0.3kg (0.66lbs)

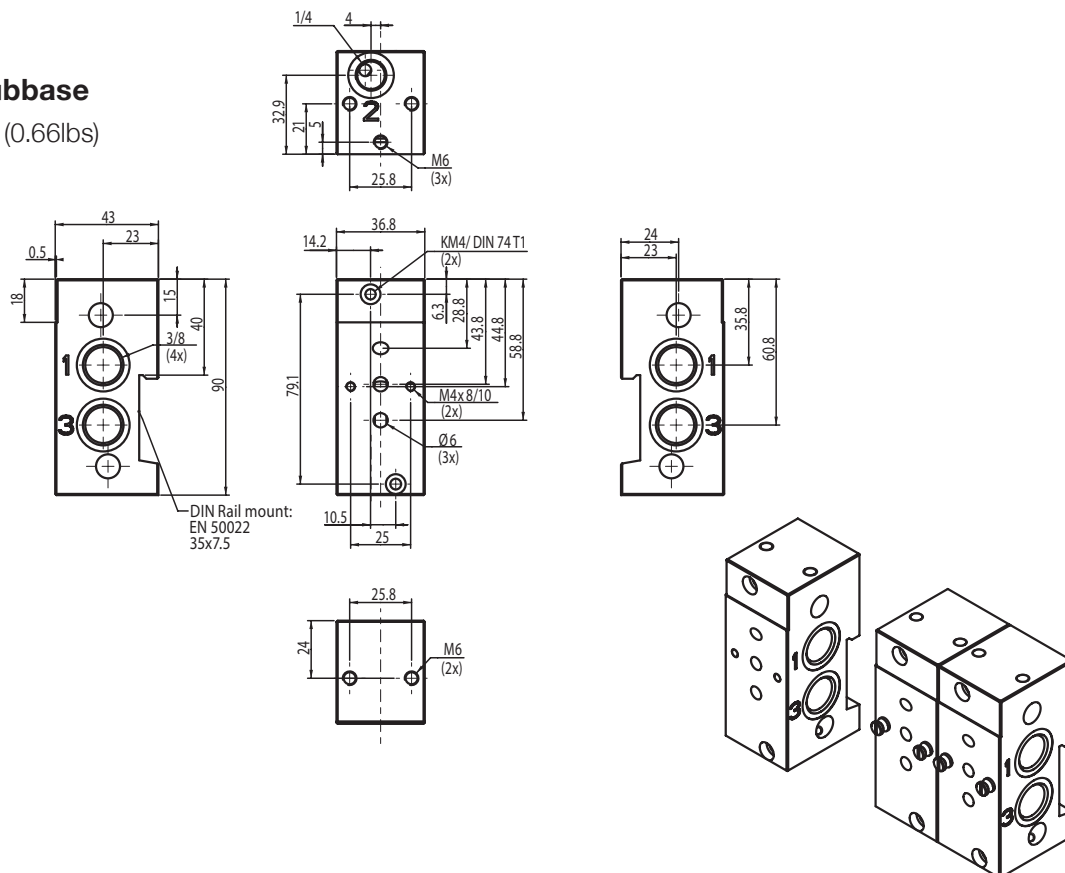

Dimensions: mm

DN 8

Weight: 0.93kg (2.05lbs)

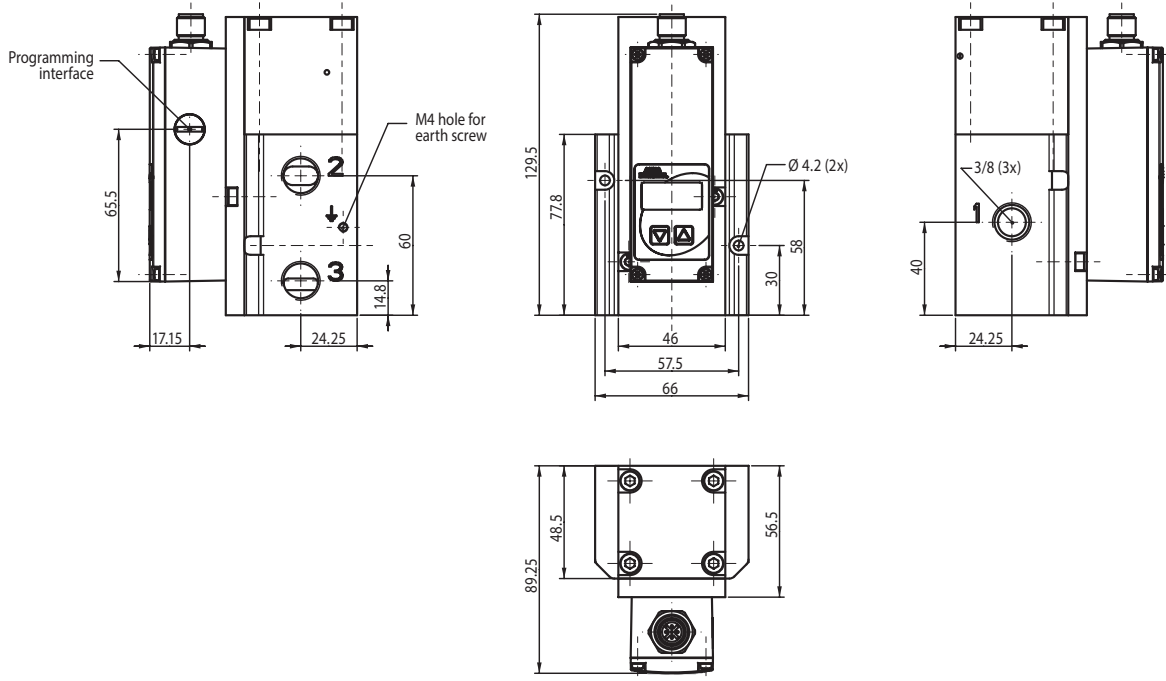

DN 15

Weight: 1.33kg (2.93lbs)

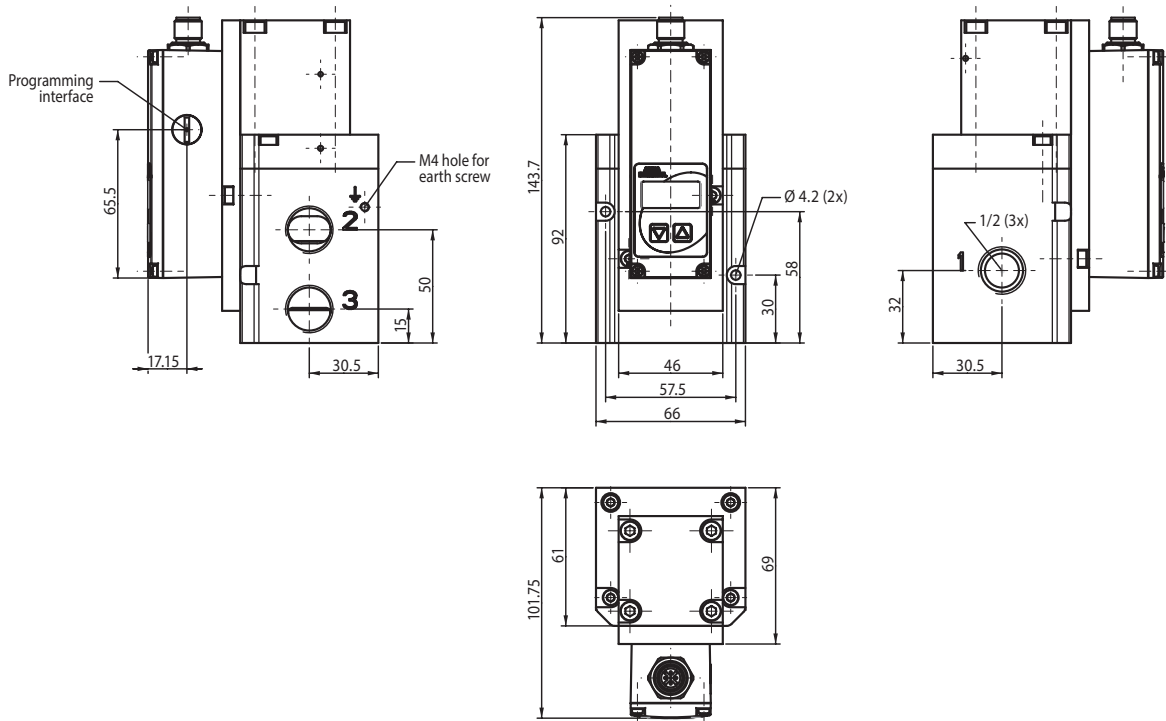

Connector Pin Out / Cable Wiring

Standard Analog Control

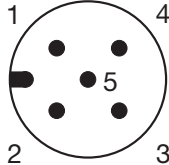

View from soldering side

| Pin | Description | 6-wire cable |
|------|----------------------------------|--------------|
| 1 | 24 VDC voltage supply | brown |
| 2 | Analog Setpoint Input | white |
| 3 | Supply common | blue |
| | Analog common* | yellow |
| 4 | Analog output (feedback) | black |
| 5 | Digital Output (pressure switch) | gray |
| Body | EMC screen | shield |

* A 6-wire cable with separate common for the command signal is used for cable lengths over 2m to minimize the voltage drop for the command signal

2 Bit, 4 Pressure Select

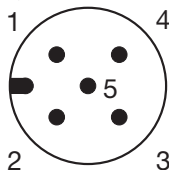

| Pin | Description |
|-----|-----------------------|
| 1 | 24 VDC voltage supply |
| 2 | Input signal 1 (LSB) |
| 3 | Supply common |
| 4 | Input signal 2 (MSB) |
| 5 | Unused |

Accessories



| 5 Pin 12mm FEMALE Straight Field Attachable Connectors | Model Number |
|--|------------------|
| PG 9 Cable Gland | TC05F20000000000 |



| 5 Pin 12mm FEMALE 90 DEGREE Field Attachable Connectors | Model Number |
|---|------------------|
| PG 9 Cable Gland | TD05F20000000000 |



| Micro Female 5 Pole Straight 6 Wire 24 AWG, Shielded | |
|--|------------------|
| 3 Meter | TC0503MMS000671Y |
| 5 Meter | TC0505MMS000671Y |



| Micro Female 5 Pole 90 Degree 6 Wire 24 AWG Euro Color Code, Shielded | |
|---|------------------|
| 3 Meter | TD0503MMS000671Y |
| 5 Meter | TD0505MMS000671Y |



| Micro F/M 4 Pole Straight 22 AWG Euro Color Code (for connecting to G3 analog I/O modules or digital I/O for 2Bit Setpoint units) | |
|--|----------------------------|
| Unshielded | Shielded |
| 3 Meter - TC0403MIETA04000 | 3 Meter - TC0403MMETA04000 |
| 5 Meter - TC0405MIETA04000 | 5 Meter - TC0405MMETA04000 |



| Micro F 90°/M Straight 22 AWG Euro Color Code (for connecting to G3 analog I/O modules or digital I/O for 2Bit Setpoint units) | |
|---|----------------------------|
| Unshielded | Shielded |
| 2 Meter - TD0403MIETA04000 | 3 Meter - TD0403MMETA04000 |
| 5 Meter - TD0405MIETA04000 | 5 Meter - TD0405MMETA04000 |

| Manifold (individual subbases that join together) | |
|--|-----------------|
| Manifold for 617 DN4 with pressure supply/exhaust 3/8 NPT & output 1/4 NPT ¹ | N50781800200000 |
| Manifold for 617 DN4 with pressure supply/exhaust G3/8 & output G1/4 (BSPP) ¹ | N50781800000000 |

| PC Software & Cable Connectors | |
|--|-----------------|
| DaS Light: Data Acquisition Software for Sentronic [®] - basic parameters - free download at asco.com | 99100110 |
| USB interface for software, 2m cable | N50930300100000 |
| RS 232 cable converter; 2m cable with 9-pin Sub-D (plug connector) | 88100732 |

¹ Manifold ships with required hardware and gaskets for connecting manifolds together.

Servotronic^{Digital}

Greater versatility in automated production processes: Due to electronics, the new generation of Servotronic products increases the range of applications and performance of pneumatic components. The Servotronic^{Digital} directly responds to all pressure control needs and indirectly meets the requirements placed in the control of physical variables, such as position, velocity, acceleration, force, mass etc. The combination of innovative pneumatic technology, high-precision mechanics and modern electronics allows for quick control of pressure in a pneumatic actuating system in relation to a signal received from the controlling electronics.

The Servotronic^{Digital} is provided with a precision-lapped steel spool and sleeve with hardened and tempered surface enabling very high pulse frequencies at extremely short response times. The Servotronic^{Digital} valve has a constant air consumption.

The valve can be adjusted to a specific application using the DaS software (Data Acquisition Software).

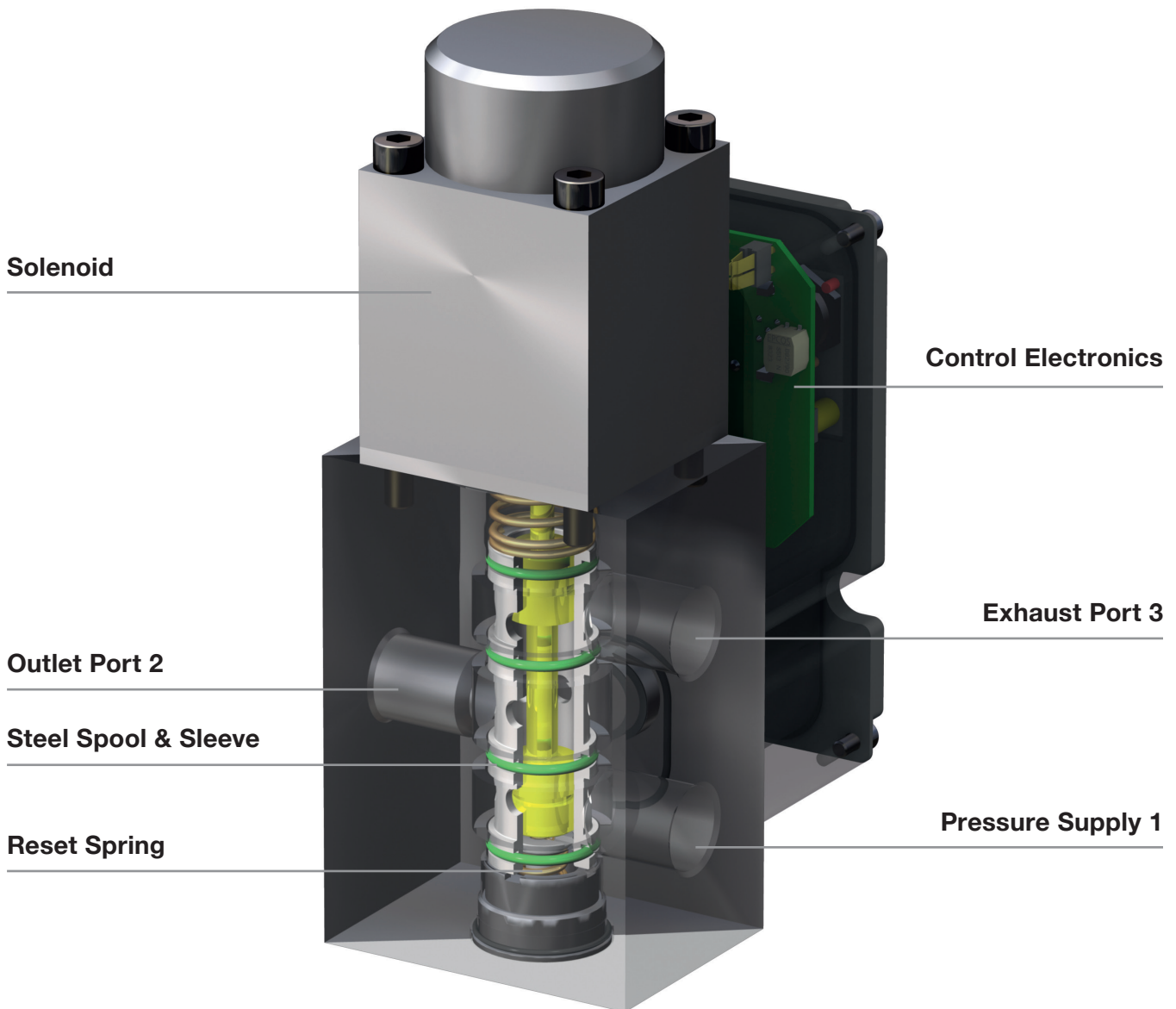

Operating Principle

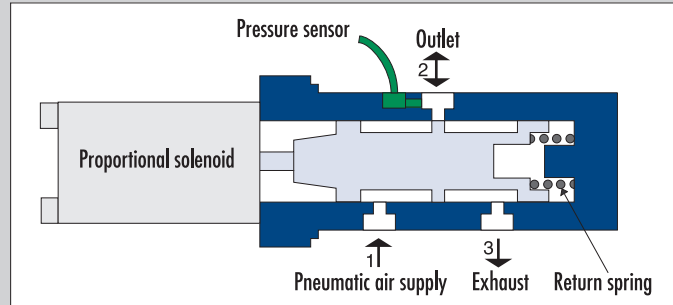

Applying pressure

The Servotronic^{Digital} consists of a spool and sleeve servo-valve with three ports and control electronics to define the pressure in proportion to a given setpoint.

The spool position can be changed continually to maintain a constant outlet pressure in relation to a given setpoint signal.

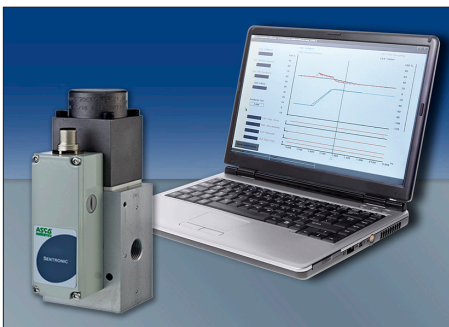

The Data Acquisition Software (DaS) and the RS232 interface allow the controller to be optimally adjusted to the control loop.

Advantages

- Minimum hysteresis
- Very short response times
- Excellent flow characteristics
- Compact monobloc construction with integrated electronics and sensor
- High reliability and long service life due to precision mechanics combined with simple control technology
- Digital control
- Easy change of control parameters

Servotronic^{Digital}

Servotronic^{Digital} is a highly dynamic 3-way proportional valve with digital control particularly suitable for applications with constant flow.

Servotronic^{Digital} stands for:

- Digital communication and control
- Direct operated valve
- Dynamic behaviour (high speed)

A special feature of the Servotronic^{Digital} is its DaS software supplied for optimum adjustment over PC and viewing of setpoint and feedback signals. Other functions are valve diagnostics, parameter setting and maintenance.

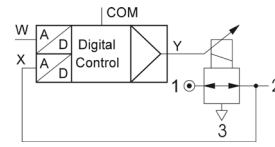

| Fluids | Ambient Temperature | Body | Internal Parts | Seals |
|---|---------------------------------|----------|---------------------------|---|
| Air or neutral gas, filtered at 50 µm, lubricated or unlubricated | 0 °C to 60 °C (32 °F to 140 °F) | Aluminum | Stainless steel and brass | FPM (fluoroelastomer) and NBR (nitrile) |

| General Valve Information | |
|----------------------------------|--|
| Maximum allowable pressure (MAP) | See table below |
| Fluid Temperature | 0 °C to 60 °C (32 °F to 140 °F) |
| Pressure Range | 0 to 40 bar |
| Setpoint | 0 – 10 V, 0 – 20 mA, 4 – 20 mA |
| Ports | G3/8 |
| Construction | Spool and sleeve valve |
| Actuation | Lifting solenoid |
| Hysteresis | 0.5% of span |
| Linearity/pressure measurement | ± 0.5% of span |
| Repeatability | ± 0.5% of span |
| Analog Setpoint | 0 – 10 V (impedance 100 KΩ), 0 – 20 mA/4 – 20 mA (impedance 250 Ω) |

| Electrical Characteristics | | | | | | |
|----------------------------|----------------|----------------|-------------------|------------------|----------------------|--|
| Nominal Diameter DN (mm) | Voltage * | Max. Power (W) | Max. Current (mA) | Insulation Class | Degree of Protection | Electrical Connection |
| 8 | 24 VDC = ± 10% | 20 | 810 | F | IP65 | 5-pin M12 connector (to be ordered separately) |

* Max. ripple: 10%

| Specifications | | | |
|----------------|-------------------|--|------------------------|
| Ø Ports | Ø Orifice DN (mm) | Flow | |
| | | C _v Flow Factor (K, Nm ³ /h) | at 6 Bar (l/min - ANR) |
| G 3/8 | 8 | 1.68 (1.45) | 1700 |

How to Order

6 1 5 3 7 0 E A S I D P P

Control Panel

D = M12 with display - non-explosionproof
E = M12 without display - explosionproof (ATEX)

Version (connection) Body

7 = Integrated electronics

Setpoint

0 = 0 - 10 Volt
1 = 0 - 20 mA
2 = 4 - 20 mA

Feedback

1 = Feedback output 0 - 10 Volt
2 = Feedback output 0 - 20 mA
3 = Feedback output 4 - 20 mA
4 = Feedback input 0 - 10 Volt*
5 = Feedback input 0 - 20 mA*
6 = Feedback input 4 - 20 mA*

Pressure Range

Output Pressure

40 = 0 - 100 mbar
50 = 0 - 500 mbar
60 = 0 - 1 bar
02 = 0 - 2 bar
03 = 0 - 3 bar
05 = 0 - 5 bar
06 = 0 - 6 bar
10 = 0 - 10 bar
12 = 0 - 12 bar
14 = 0 - 14 bar
16 = 0 - 16 bar
20 = 0 - 20 bar
30 = 0 - 30 bar
4H = 0 - 40 bar

Options

A00 = Dual loop control
018 = Oxygen clean

Max. Inlet

Pressure (bar)

2
2
2
3
8
8
12
12
14
18
22
35
45

Vacuum (relative)

V3 = 0 to -1 bar
shut-off valve

Digital Output

1 = Pressure switch output
PNP ± 5%

* Feedback input is needed for dual loop units.

Dimensions: inches (mm)

Weight: 1.76kg (3.88lbs)

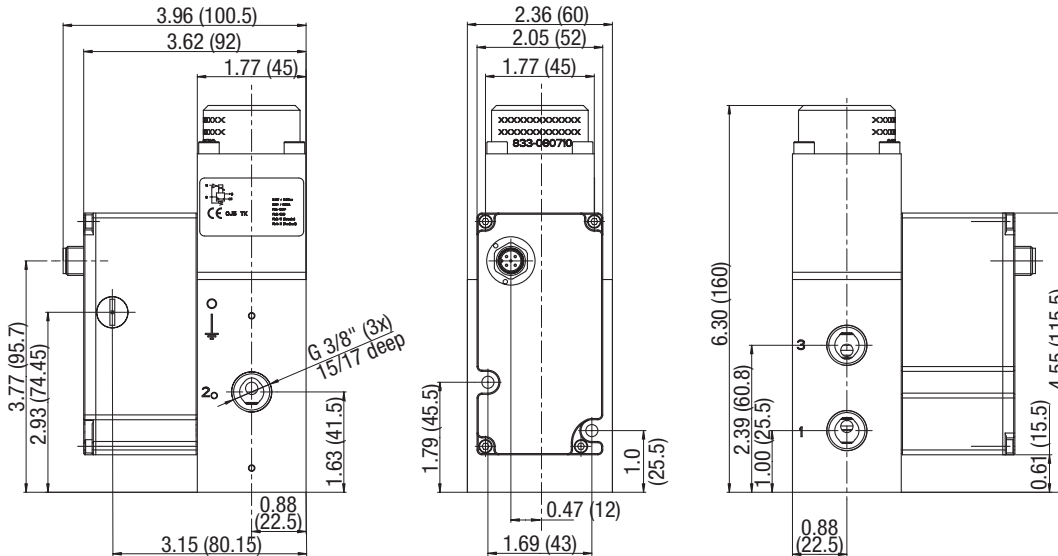

Connector Pin Out

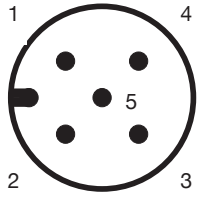

| Pin | Description | 6-wire cable |
|------|----------------------------------|--------------|
| 1 | 24V voltage supply | brown |
| 2 | Analog setpoint input | white |
| 3 | Supply ground | blue |
| | Analog ground* | yellow |
| 4 | Analog output (feedback) | black |
| 5 | Digital output (pressure switch) | grey |
| Body | EMC shield | shield |

* A 6-wire cable with separate analog ground is used for cable lengths over 2m to set off the voltage drop for the setpoint.

Accessories

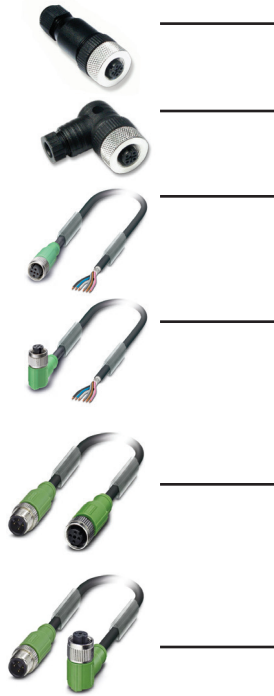

| 5 Pin 12mm FEMALE Straight Field Attachable Connectors | | Model Number |
|--|--|----------------------------|
| PG 9 Cable Gland | | TC05F20000000000 |
| 5 Pin 12mm FEMALE 90 DEGREE Field Attachable Connectors | | Model Number |
| PG 9 Cable Gland | | TD05F20000000000 |
| Micro Female 5 Pole Straight 6 Wire 24 AWG, Shielded | | |
| 3 Meter | | TC0503MMS000671Y |
| 5 Meter | | TC0505MMS000671Y |
| Micro Female 5 Pole 90 Degree 6 Wire 24 AWG Euro Color Code, Shielded | | |
| 3 Meter | | TD0503MMS000671Y |
| 5 Meter | | TD0505MMS000671Y |
| Micro F/M 4 Pole Straight 22 AWG Euro Color Code | | |
| Unshielded | | Shielded |
| 2 Meter - TC0403MIETA04000 | | 3 Meter - TC0403MMETA04000 |
| 5 Meter - TC0405MIETA04000 | | 5 Meter - TC0405MMETA04000 |
| Micro F 90°/M Straight 22 AWG Euro Color Code | | |
| Unshielded | | Shielded |
| 2 Meter - TD0403MIETA04000 | | 3 Meter - TD0403MMETA04000 |
| 5 Meter - TD0405MIETA04000 | | 5 Meter - TD0405MMETA04000 |
| PC Software & Cable Connectors | | Model Number |
| DaS Light: Data Acquisition Software for Sentronic ^D - basic parameters - free download at asco.com | | 99100110 |
| DaS Expert: Data Acquisition Software for Sentronic ^D - full parameters | | Consult Factory |
| RS 232 cable converter; 2m cable with 9-pin Sub-D (plug connector) | | 88100732 |

Flowtronic^D

Flowtronic^D is a digitally operated flow controller up to 70 SCFM (2000 NI/min). The Flowtronic^D consists of a fast, direct-operated 2-port proportional valve that operates independently of the inlet pressure (max. 116 psi), and a control unit which contains all of the control electronics and sensors. The Flowtronic^D offers precise flow adjustment and is very responsive to outside disturbances.

Typical applications for the Flowtronic^D include: Paint coating technology, mixing of gases in process control, packaging and food processing industry, surface finishing and materials coating processes, burner control systems, and fuel cell technology.

The digital control electronics and a USB interface allow the controller to be adapted to different applications. The ASCO FlowCom PC software provides easy start-up.

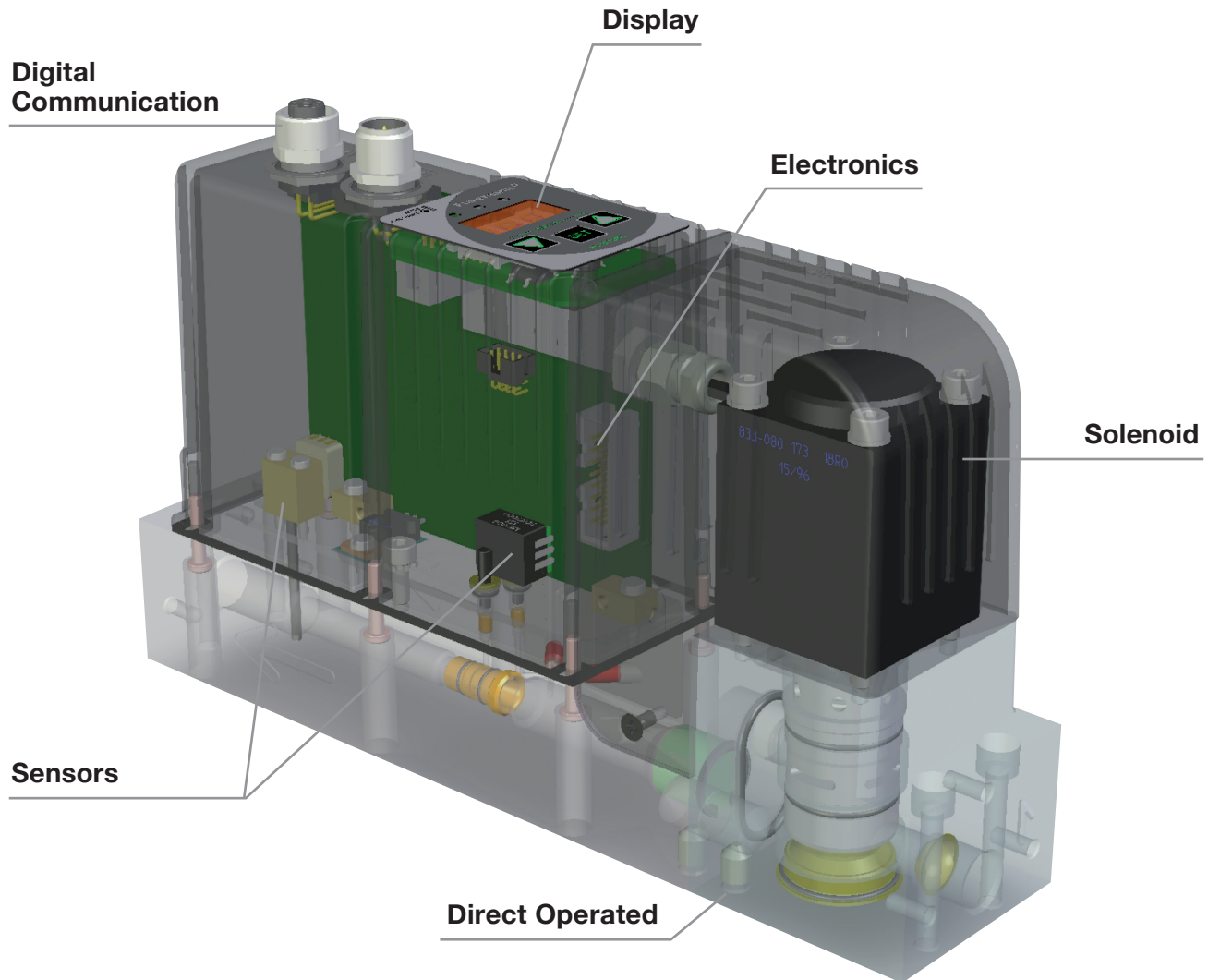

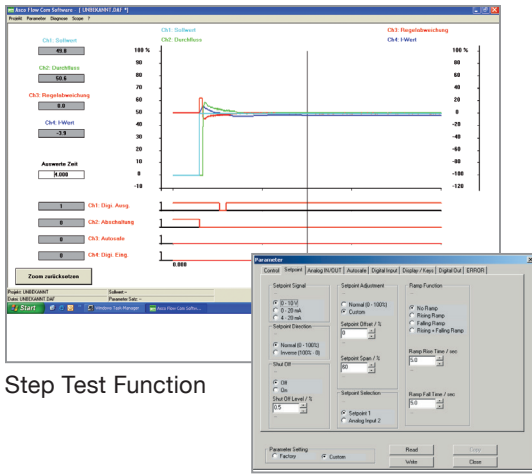

Step Test Function

Parameters Setup

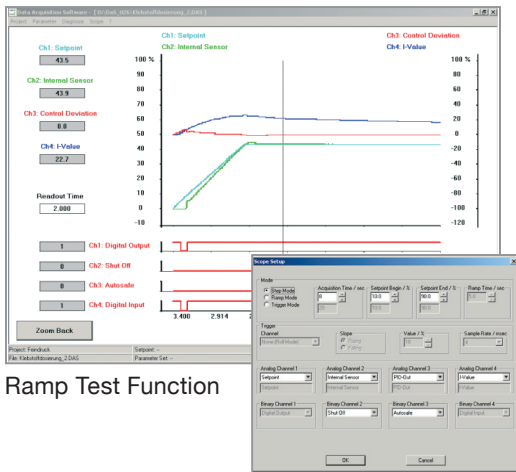

Ramp Test Function

Scope Setup

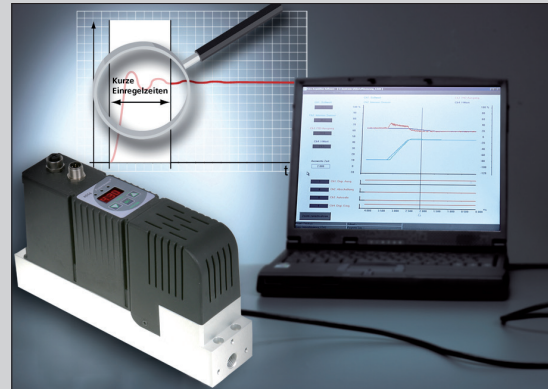

By connecting the Flowtronic^D to a PC with a USB interface, the Numatics FlowCom software can be used to optimally adjust the valve's control parameters to a specific application. FlowCom software has an oscilloscope function that allows the user to select and visually see various response characteristics as the flow controller operates in an application. Control loop parameters can be adjusted using the software without removing the flow controller from service. This functionality streamlines the application development process. Control parameters can be saved and reloaded at any time.

The ASCO FlowCom software offers the following features:

- Real time display of: command signal, outlet pressure, internal control parameters (e.g. P, I or D), pressure switch signal, etc.
- Parameter setting: command signal, zero offset, span, limitation of output current, ramp function, etc.
- Diagnostics menu for error detection and testing
- Custom adjustment to an application
- Control of Flowtronic^D

Advantages

- Low hysteresis
- Quick response times
- Very high sensitivity
- Standard 50 µm filtration
- Analog feedback output
- Easy change of control parameters
- Digital control
- Integrated display (optionally without)
- PC communication

Flowtronic^D

- The Flowtronic^D consists of a fast, direct-acting 2-port proportional valve, a pressure sensor unit and digital control electronics
- Controls applications that have varying flow
- Controls and maintains constant and even flow despite external disturbances such as fluctuating inlet pressure
- Measures flow precisely with two sensors
- Software and PC connection allows parameters to be adjusted to a specific application
- FlowCom software provides quick and easy start-up
- Diagnostic capability using the integrated LEDs or the FlowCom software



| Fluids | Ambient Temperature | Body | Internal Parts | Seals |
|--|---------------------------------|----------|-------------------------------------|---------------|
| Air or neutral gas, filtered at 50 µm, condensate-free, lubricated or unlubricated | 0 °C to 40 °C (32 °F to 104 °F) | Aluminum | Aluminum, stainless steel and brass | NBR (nitrile) |

| General Valve Information | | |
|----------------------------------|--|-------------------------------------|
| Minimum allowable pressure | 5 bar (58 psi) | |
| Maximum allowable pressure (MAP) | 8 bar (116 psi) | |
| Control range | 0.4 – 70.6 SCFM, (10 – 2000 NI/min) (ANR) | |
| Fluid Temperature | 0 °C to 50 °C (32 °F to 122 °F) | |
| Pressure Range | up to 116 psi (8 bar) | |
| Ports | 1/4, 3/8, 1/2 NPT or GTap | |
| Construction | Poppet valve | |
| Command signal - analog | 0 – 10 V (100 kΩ), 0 – 20 mA, 4 – 20 mA (resistance 250 Ω) | |
| Feedback output - analog | 0 – 10 V, 0 – 20 mA, 4 – 20 mA (max. load 500 Ω) | |
| Hysteresis | ± 3% | |
| Linearity/pressure measurement | ± 3% | |
| Repeatability | ± 1.5% | |
| Response time | < 200ms | |
| Calibration conditions | Ambient temperature | 22.5 °C ± 2.5 °C (72.5 °F ± 4.5 °F) |
| | Fluid | Air |
| Nominal diameter | 3mm, 5mm, 6mm | |
| Other features | Auto-tune, error display by LED | |

| Electrical Characteristics | | | | | | |
|----------------------------|----------------|----------------|-------------------|------------------|----------------------|--|
| Nominal Diameter DN (mm) | Voltage * | Max. Power (W) | Max. Current (mA) | Insulation Class | Degree of Protection | Electrical Connection |
| Up to 1000 NI/min | 24 VDC = ± 10% | 30 | 1250 | H | IP65 | - 5-pin M12 connector - USB connection with 4 pin M12 connector |
| 2000 NI/min | 24 VDC = ± 10% | 34 | 1400 | H | IP65 | - 5-pin M12 connector - USB connection with 4 pin M12 connector |

* Max. ripple: 10%

How to Order

8 3 3 - 3 8 0 1 0 1 1 5 0

Version (ports), Body/Display

- 0 = (GTap) without display*
- 1 = (GTap) with display*
- 2 = 1/2 (GTap) without display
- 3 = 1/2 (GTap) with display
- 6 = (NPT) without display*
- 7 = (NPT) with display*
- 8 = 1/2 (NPT) without display
- 9 = 1/2 (NPT) with display

Command Signal

- 0 = 0 – 10 Volt
- 1 = 0 – 20 mA
- 2 = 4 – 20 mA

Feedback

- 1 = Feedback output 00 – 10 Volt
- 2 = Feedback output 00 – 20 mA
- 3 = Feedback output 04 – 20 mA
- 4 = Feedback input 0 – 10 Volt¹⁾
- 5 = Feedback input 0 – 20 mA¹⁾
- 6 = Feedback input 4 – 20 mA¹⁾

Options

A00 = Dual loop control

Flow Regulation Range

- 10 = 0.4 - 3.5 SCFM (10 - 100 NI/min)
(1/4 - Versions 0, 1, 6 or 7 only)
- 20 = 0.4 - 7.1 SCFM (10 - 200 NI/min)
(1/4 - Versions 0, 1, 6 or 7 only)
- 30 = 0.4 - 10.6 SCFM (12 - 300 NI/min)
(1/4 - Versions 0, 1, 6 or 7 only)
- 50 = 0.7 - 17.7 SCFM (20 - 500 NI/min)
(1/4 - Versions 0, 1, 6 or 7 only)
- 60 = 0.8 - 21.2 SCFM (22 - 600 NI/min)
(1/4 - Versions 0, 1, 6 or 7 only)
- 99 = 1.8 - 35.3 SCFM (50 - 1000 NI/min)
(3/8 - Versions 0, 1, 6 or 7 only)
- 20 = 3.5 - 70.6 SCFM (100 - 2000 NI/min)
(1/2 - Versions 2, 3, /8 or 9 only)

Digital I/O

1 = Pressure switch output PNP ± 5%

Notes:

* Port size depends on flow range (1/4 or 3/8)

¹⁾ Feedback input is needed for dual loop units.

Connector Pin Out

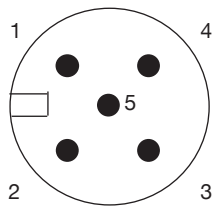

| Pin | Description |
|------|----------------------------------|
| 1 | +24 VDC Supply |
| 2 | Command Signal |
| 3 | +0 VDC Common (Supply) |
| | +0 VDC Common (Command Signal)* |
| 4 | Analog output (feedback) |
| 5 | Digital output (pressure switch) |
| Body | EMC shield |

* A 6-wire cable with separate common for the command signal is used for cable lengths over 2m to minimize the voltage drop for the command signal.

Dimensions: inches (mm)

Weight: 1.85kg (4.08lbs)

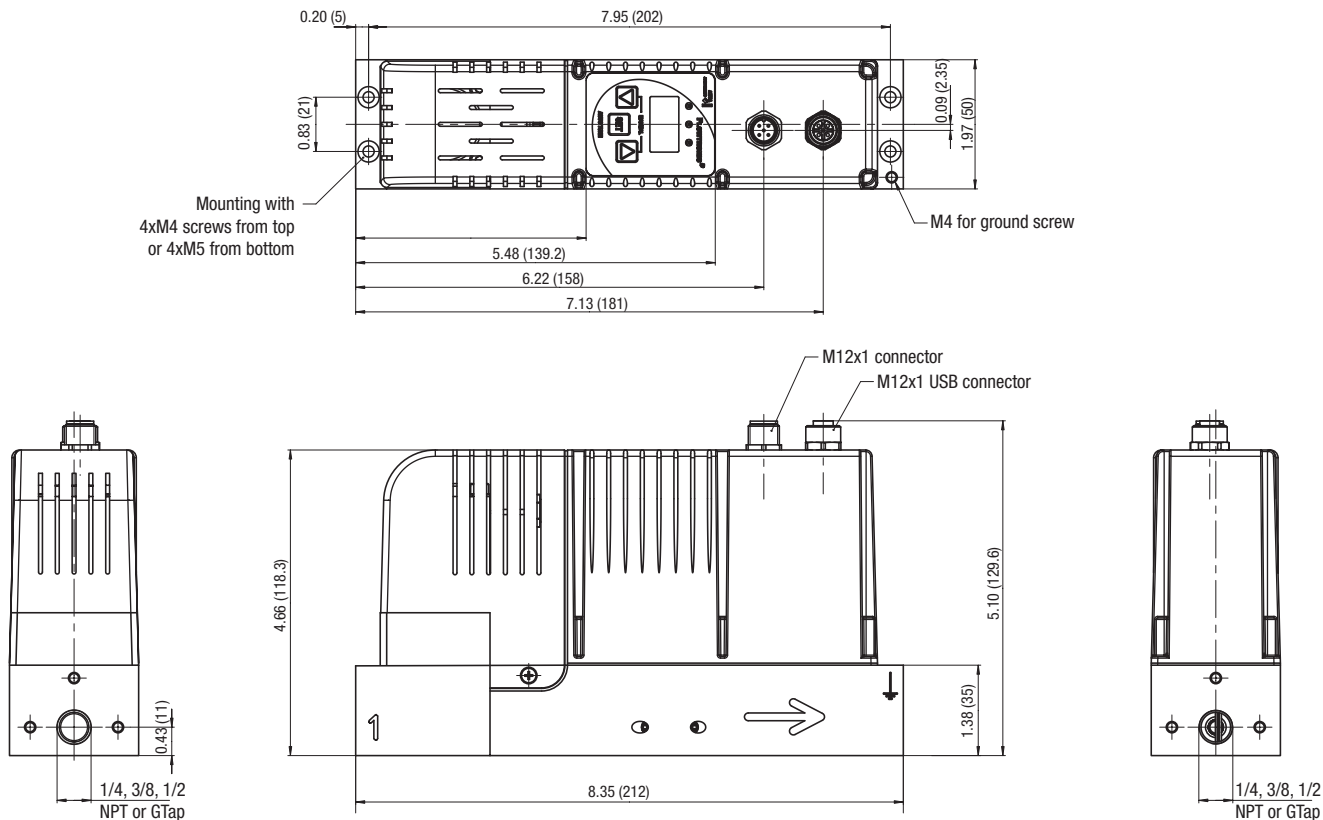

Accessories



| | |
|---|---------------------|
| 5 Pin 12mm FEMALE Straight Field Attachable Connectors | Model number |
| PG 9 Cable Gland | TC05F20000000000 |
| 5 Pin 12mm FEMALE 90 DEGREE Field Attachable Connectors | |
| PG 9 Cable Gland | TD05F20000000000 |
| Micro Female 5 Pole Straight 6 Wire 24 AWG, Shielded | |
| 3 Meter | TC0503MMS000671Y |
| 5 Meter | TC0505MMS000671Y |
| Micro Female 5 Pole 90 Degree 6 Wire 24 AWG Euro Color Code, Shielded | |
| 3 Meter | TD0503MMS000671Y |
| 5 Meter | TD0505MMS000671Y |
| PC Software & Cable Connector | Model number |
| Flowtronic [®] software "ASCO-FlowCom-Light" - free download at asco.com | 88100895 |
| Flowtronic [®] software "ASCO-FlowCom-Expert" - CD-ROM | Consult Factory |
| USB cable for connection of Flowtronic [®] to PC | 88100897 |

Control^D

The stand-alone control device Control^D is used for open-loop, closed-loop or dual-loop (cascaded) process control. It is designed to control proportional valves by regulating the current in the valve's solenoid coil. The maximum value of the solenoid coil's current is automatically determined with the auto-tune function. More complex applications can be controlled using additional analog inputs of flow, temperature, pressure, force, etc.

A serial RS232 or a mini USB interface allows communication with a PC where the included Numatics DigiCom software can be used to adapt the controller to the control loop. Three buttons and a 3-digit LED display on the device enable manual setpoint setting and display of feedback without the need for PLC control during start-up. Additional LEDs show the operating state and any error messages (e.g. low voltage, overvoltage, setpoint not reached) that may occur.

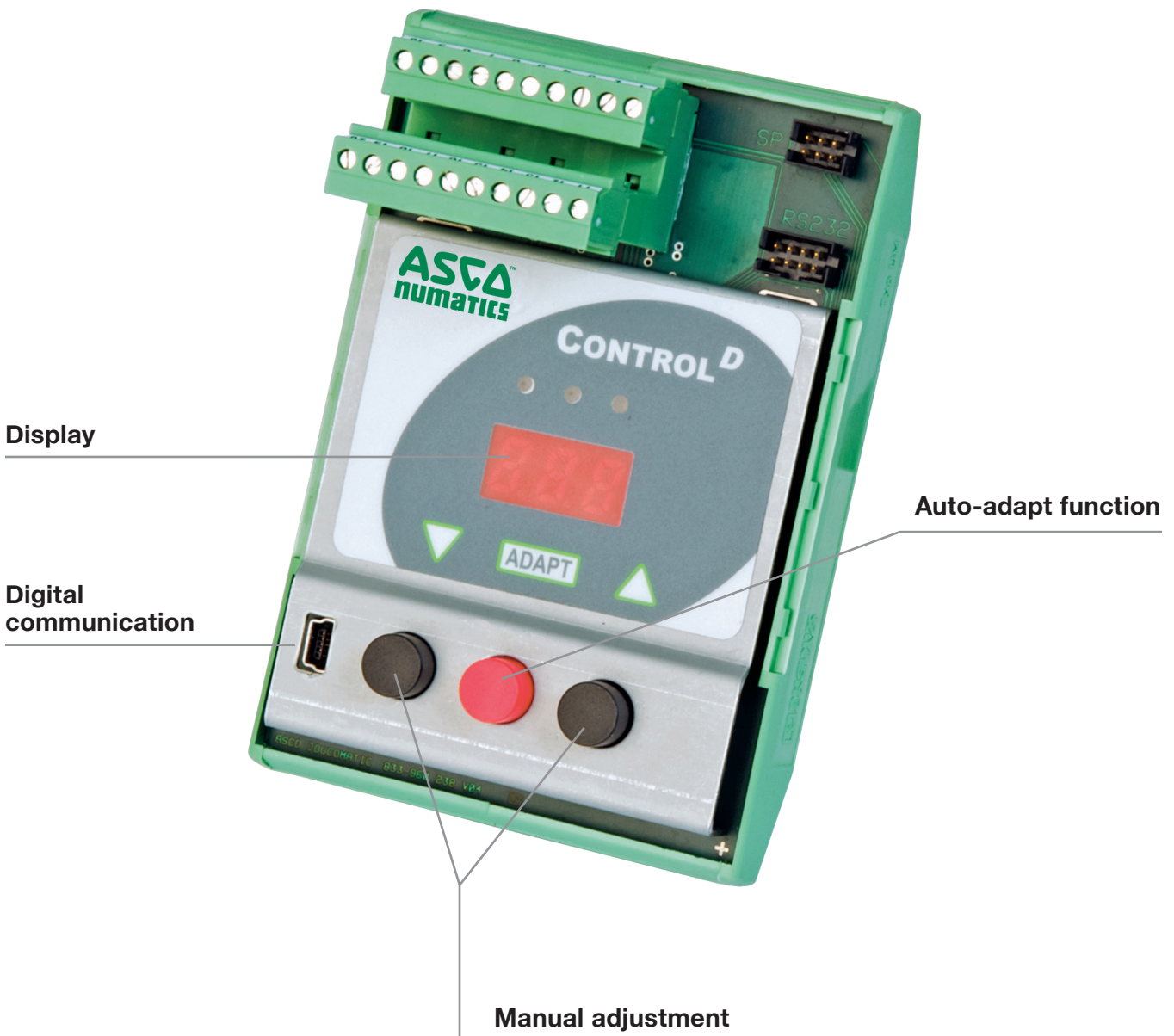

Open-Loop Control

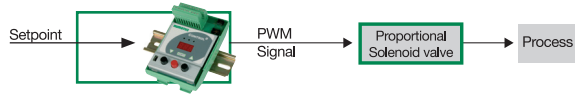

Closed-Loop Control

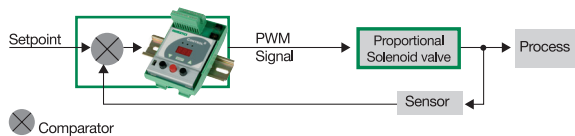

Double-Loop (Cascaded) Control

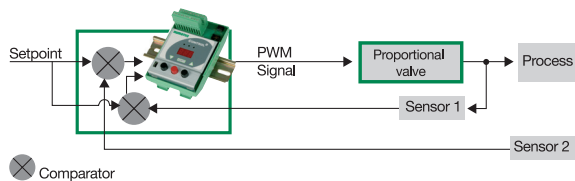

Advantages

- Low hysteresis
- Easy change of control parameters
- Digital control
- Integrated Display
- AUTO-ADAPT button for determining max. coil current
- PC communication
- Configurable analog feedback output
- Switching output
- Scope function using DigiCom software
- USB interface
- Suitable for use with Posiflow, Preciflow and Sentronic
- Direct input for open-loop control (no measuring device required)
- Easy to duplicate control parameters

DigiCom Software



By connecting the Control^D to a PC with a USB interface, the ASCO DigiCom software that comes with the product can be used to optimally adjust the valve's control parameters to a specific application.

- The scope function allows you to log and read the system's transient response in real time.
- Control parameters can be adjusted to an application without removing the controller from service.
- Saved control parameters can be loaded at any time.

The ASCO DigiCom software offers the following features:

- Real time display of: command signal, outlet pressure, internal control parameters (e.g. P, I or D), pressure switch signal, etc.
- Parameter setting: command signal, zero offset, span, limitation of percentage of output current, ramp function, etc.
- Custom adjustment to an application
- Control of proportional devices such as Posiflow, Preciflow or proportional pressure regulator valves

Control^D

- Control device for PWM (pulse-width modulated) proportional solenoid valve control
- Designed for open-loop, closed-loop and double-loop (cascaded) control
- Suitable for the control of flow, pressure, temperature, force, etc.
- Integrated display and LEDs
- Control parameters adjustable via software (DigiCom, USB interface)
- Auto-Adapt function/button for automatic adjustment of the Control^D control device to the control valve

A special feature of the Control^D is the "ASCO-DigiCom" software supplied for optimum adjustment over PC. Setpoint and feedback values can be viewed at the same time. Other functions are valve diagnostics, parameter setting and maintenance.



| General Valve Information | |
|---------------------------|---|
| Temperature Range | -20 °C to 50 °C (-4 °F to 122 °F) |
| Body | PA (polyamide) |
| Degree of Protection | IP20 |
| Electrical Connection | Pluggable terminal block (0.08 – 1.5mm ²) |
| Mounting | DIN-EN 50022 rail |
| Nominal voltage | 24/12 VDC +/- 10% |
| Command signal | 0 – 10 V, 0 – 20 mA, 4 – 20 mA |
| Current adjustment | 0– 2A |
| Pressure control | 0 – 100% |
| Process control | 0 – 100% |
| Serial interface | Mini USB or RS 232 (option) |

| Electrical Characteristics | |
|---|--|
| Supply Voltage | (U _i) 24 VDC ±10%, max. ripple 10% or 12 VDC +15% -5%, max. ripple 10% |
| Max. Current of Proportional Solenoid Valve | 0.2A/2A |
| Setpoint Input | 0 – 10 VDC, 0 – 20 mA, 4 – 20 mA |
| Sensor Input | 0 – 10 VDC, 0 – 20 mA, 4 – 20 mA |
| Feedback Output | 0 – 10 V, 0/4 – 20 mA |
| Ramp | ON/OFF, adjustable between 0.1 and 20 seconds |
| Adjustable Switching Frequency | 20 to 2000 Hz |

| Specifications | |
|---|----------------|
| Description | Catalog Number |
| Control ^D control device - 12 VDC/2 A | 60300117 |
| Control ^D control device - 24 VDC/2 A | 60300118 |
| Control ^D control device - 24 VDC/200 mA | 60300119 |

Control^D offers 3 control modes

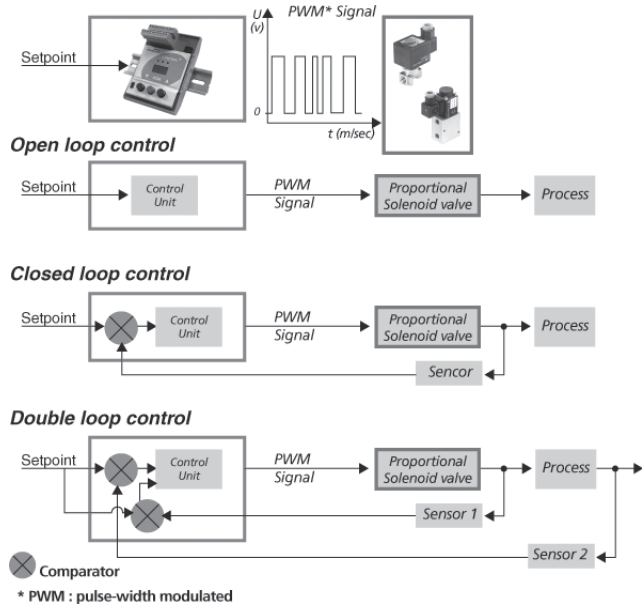

Dimensions: mm (inches)

Weight: 0.15kg (0.33 lbs)

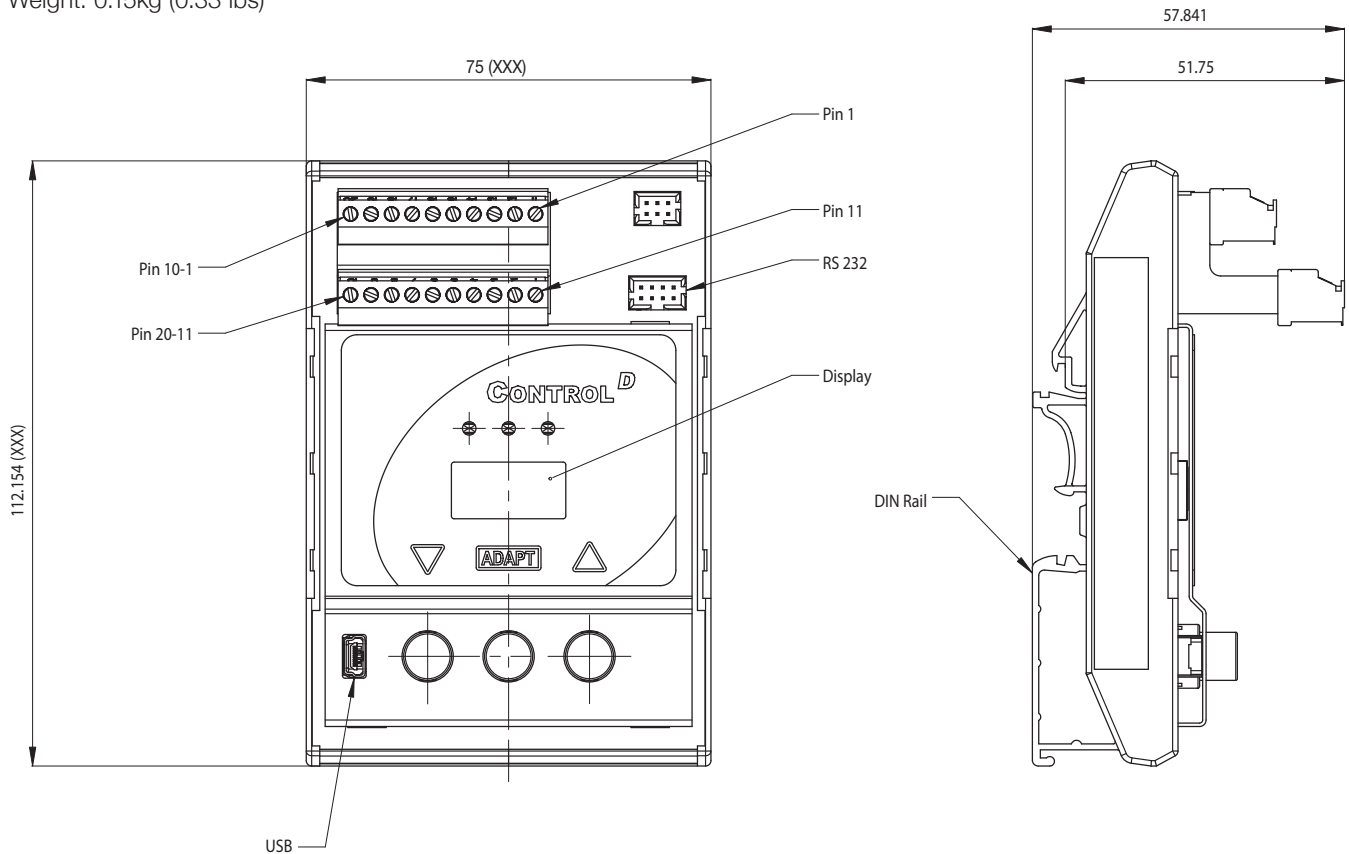

Connector Pinning

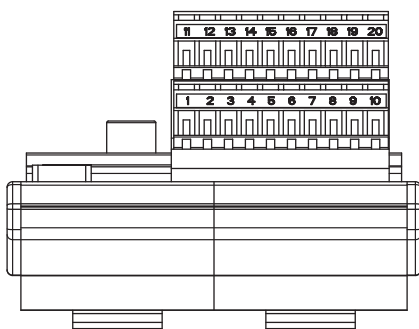

| Pin | Description | Pin | Description |
|-----|---------------------------|-----|-----------------------|
| 1 | V DC IN/ + supply | 11 | Setpoint |
| 2 | GND IN/ ground | 12 | GND setpoint |
| 3 | Protective earth PE | 13 | Digital input |
| 4 | Frequency input | 14 | GND Digital input |
| 5 | Sensor supply voltage + | 15 | Valve/coil connection |
| 6 | Analog input 1 | 16 | GND valve |
| 7 | GND sensor supply voltage | 17 | Digital output |
| 8 | Sensor supply voltage + | 18 | GND Digital output |
| 9 | Analog input 2 | 19 | GND Analog output |
| 10 | GND sensor supply voltage | 20 | Analog output |

Accessories

| Description | Catalog Number |
|---|----------------|
| "ASCO-DigiCom" Control ^D software on CD-ROM (supplied with the controller) | 88100893 |
| USB cable for Control ^D to PC connection (to be ordered separately) | 88100894 |
| RS 232 cable converter; 2m cable with 9-pin Sub-D (plug connector) | 88100732 |
| RS 232 cable converter; 2m cable with 9-pin Sub-D (screw connector) | 833-993708 |



Global Contacts

| | | | | | |
|----------------|-------------------|---------|--------------------|----------------|------------------|
| Australia | (61) 2-9-451-7077 | France | (33) 2-37-24-42-24 | Netherlands | (31) 33-277-7911 |
| Brazil | (55) 11-4208-1700 | Germany | (49) 7237-9960 | Singapore | (65) 6556-1100 |
| Canada | (1) 519-758-2700 | India | (91) 44-39197300 | South Korea | (82) 2-3483-1570 |
| China | (86) 21-3395-0000 | Italy | (39) 02-356931 | Spain | (34) 942-87-6100 |
| Czech Republic | (420) 235-090-061 | Japan | (81) 798-65-6361 | United Kingdom | (44) 1695-713600 |
| Dubai - UAE | (971) 4-811-8200 | Mexico | (52) 55-5809-5640 | | |