

# NUMATICS®

## AR Series

Rotary Actuator



[www.numatics.com](http://www.numatics.com)

  
**EMERSON**  
Industrial Automation

**BCAE**  
Automation Solutions

青岛秉诚自动化设备有限公司  
地址：中国·青岛市重庆南路99号海尔云街甲3号楼7F

服务热线：4006-918-365  
网址：<http://www.ivalve.cc>

传真：(86-532)585-10-365  
Email：[sales@bechinas.com](mailto:sales@bechinas.com)

## AR Series

Features and Benefits	3
How to Order	4
Dimensions	5
Technical Specifications	6
NuMate Compatibility	7
Sensing Part Numbers	8-10
Quick Disconnect Cables	11

## Rotary Actuator Utilizes a Dual Rack-n-Pinion System

The Torque Rack produces the rotary output torque while the control rack determines rotary stroke.

The output shaft is supported by two angular contact bearings. The *NuMate* mounting feature provides a convenient method of mounting the AR-Rotaries to the SH-Series linear slide.

### A. Body:

#### Hardcoat Anodized Aluminum

Lightweight, durable, high strength to weight ratio, PTFE impregnated inside and out.

#### Multiple mounting surfaces

Flexible, easy access mounting.

### B. Output Shaft:

#### Hardened electroless nickel

Corrosion and wear resistance.

#### Angular Contact Bearings

Two angular contact bearings better supporting both thrust and radial loads.

### C. Stroke Adjustment:

#### Clockwise and Counter Clockwise Adjustment over 185° total stroke

Infinite adjustment in both directions of rotation, secured by jam nut.

### D. Sensor Mounting Channel:

#### Machined into body

Accepts Numatics Motion Control dovetail switches, easy access, easy adjustment

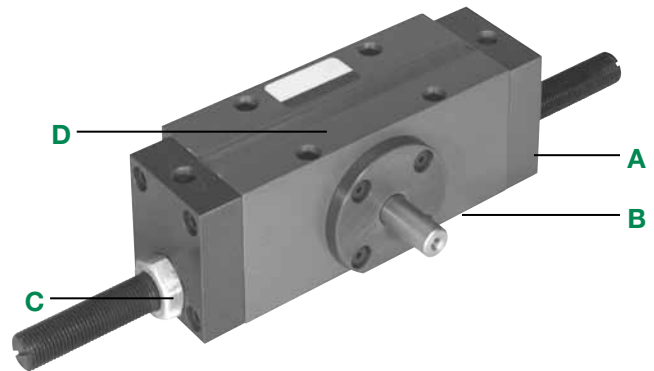

Magnetic piston is standard on all models.

Permanently lubricated seals are standard on all models, no lube required. FKM compound for high temperature applications, optional.

Additional options:

- Shock absorbers
- Double output shaft

How to Order

AR 020 A 1 A Z C 1 X

**Bore Sizes**

- 020 = 20 mm
- 025 = 25 mm
- 032 = 32 mm

**Rotation**

- A = 90°-180°

**Seal Option**

- 1 = Buna
- 2 = FKM

**Shaft Option**

- A = Standard Single Shaft End
  - Z = Additional Double Shaft End\*
- \*Tapped both ends.

**Disk Size\*\***

- A = NuMate Disk 020
- B = NuMate Disk 025
- C = NuMate Disk 032
- X = No Disk

**Shock Options**

- 1 = Shocks Yes
- 2 = Shocks No

**Sensing Position**

- A = Single Position CW
- B = Single Position CCW
- C = Two Position
- D = No Sensing

**Sensing Type**

- Standard Cord Set
    - 1 = Hall Effect - PNP (sourcing)
    - 2 = Hall Effect - NPN (sinking)
    - 3 = Reed Switch
    - 6 = No Sensing
  - Quick Disconnect Cord Set
    - Z = Hall Effect - PNP (sourcing)
    - Y = Hall Effect - NPN (sinking)
    - X = Reed Switch
- See page 7.

**Example order:**

**Part Number: AR020A1AZC1X\***

Part Description: AR rotary with 20mm bore, 90° rotation, standard seals, standard single output shaft, Hall PNP quick disconnect sensing, two positions, with shocks without NuMate disk.

\*When entering an order, DO NOT use spaces or dashes. Follow example above.

Replacement Components and Kits

AR Rotary Seal Kit

Series	Buna	FKM
AR020	ARSKB-020	ARSKV-020
AR025	ARSKB-025	ARSKV-025
AR032	ARSKB-032	ARSKV-032

Replacement	Shocks
AR020	SK030
AR025	SK106
AR032	SK106

NuMate Disk

The NuMate Disk provides a simple solution for combining rotary and linear motion

\*\*Compatibility Table

AR Series	SH Series	ND
AR020	SH056	ND020
AR025	SH075	ND025
AR032	SH106	ND032

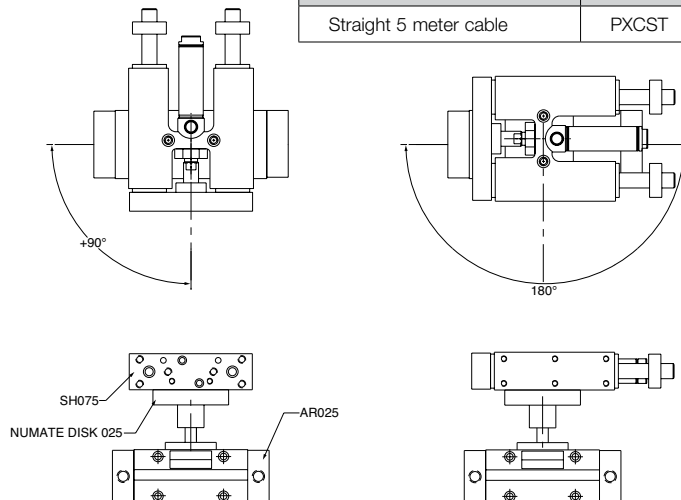

Sensing Kits

Standard Cord Set	
Switch	Part No.
Hall Effect PNP (Sourcing)	PNP-FL2-00-U
Hall Effect NPN (Sinking)	NPN-FL2-00-U
Reed Switch	REED-FL2-00
Quick Disconnect Cord Set	
Part No.	
Hall Effect PNP (Sourcing)	PNP-QDS-M8-U
Hall Effect NPN (Sinking)	NPN-QDS-M8-U
Reed Switch	REED-QDS-M8U
90° 5 meter cable	PXC90
Straight 5 meter cable	PXCST

## Dimensions: Inches

### AR Series

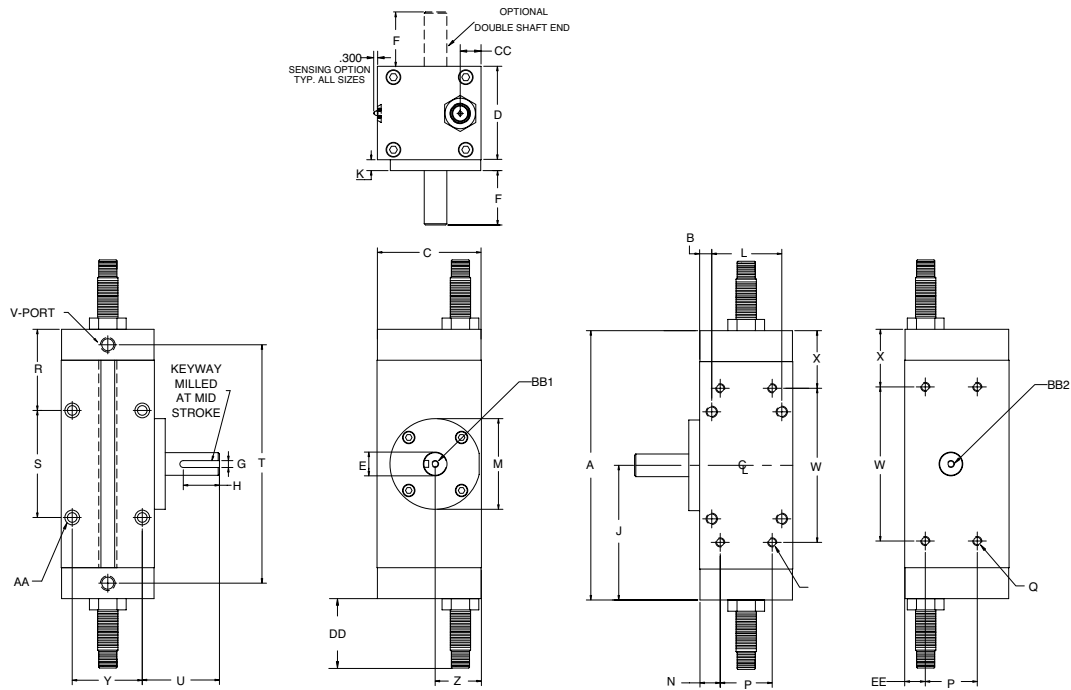

	AR020	AR025	AR032
A	5.18	6.43	7.43
B	0.22	0.22	0.33
C	1.83	2.25	2.89
D	1.76	2.12	2.56
E	0.37	0.47	0.63
F	1.00	1.00	1.50
G	0.093 X 0.054/0.058 DP	0.125 X 0.070/0.074 DP	0.187 X 0.105/0.110 DP
H	0.65	0.75	1.00
J	2.58	3.21	3.71
K	0.24	0.25	0.30
L	1.31	1.57	1.94
M	1.87	2.125	2.50
N	0.47	0.49	0.56
P	0.81	1.13	1.44
Q	10-32	1/4-20	1/4-20
R	1.50	2.02	2.23
S	2.16	2.37	2.96
T	4.46	5.71	6.57
U	1.46	1.75	2.13
V	1/8 NPT	1/8 NPT	1/8 NPT
W	3.38	3.81	4.26
X	0.90	1.30	1.58
Y	1.31	1.57	1.94
ZZ	0.80	0.98	1.27
AA	C' Bored for M4 SHCS, Tapped M5 X 0.8 from opposite side	C' Bored for M5 SHCS, Tapped M8 X 1.25 from opposite side	C' Bored for M6 SHCS, Tapped M8 X 1.25 from opposite side
BB1	M3 X 0.5	M5 X 0.8	M5 X 0.8
BB2	M3 X 0.5	M5 X 0.8	M5 X 0.8
CC	0.40	0.51	0.58
DD	1.31	1.50	1.81
EE	0.40	0.42	0.56

AR Series

Model	Torque @ 100PSI	Dynamic Thrust Load	Dynamic Radial Load	Displacement per Degree	Unit Weight	Maximum Pressure
AR020	14.6 inlb (1.6 N-m)	106 lbf (471 N)	421 lbf (1872 N)	0.0026 cuin. (0.043 cc)	2.3 lbs	250 psi
AR025	29.4 inlb (3.3 N-m)	127 lbf (564 N)	501 lbf (2228 N)	0.0052 cuin. (0.085 cc)	3.1 lbs	250 psi
AR032	61.3 inlb (6.9 N-m)	191 lbf (849 N)	677 lbf (3011 N)	0.0108 cuin. (0.177 cc)	5.7 lbs	250 psi

Shock Option

Face Mounting

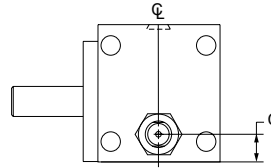
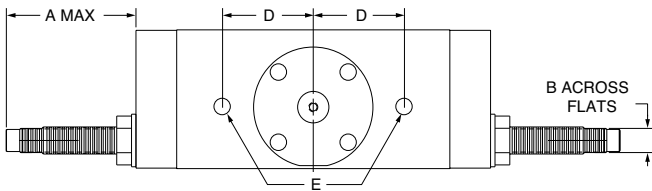

	AR020	AR025	AR032
A	2.70	2.70	2.75
B	0.49	0.49	0.49
C	0.40	0.51	0.58
D	1.69	1.90	2.12
E	M5	M6	M8

Kinetic Energy Basic Formula

$$KE = 1/2 J \omega^2$$

$$\omega = 0.035 \times \frac{\text{Angle traveled (deg.)}}{\text{Rotation time (sec)}}$$

KE = Kinetic Energy

J = Rotational mass moment of inertia (in-lb-sec<sup>2</sup>)  
(dependent on physical size of object and weight)

W = Peak Velocity (rad/sec) (Assuming twice average velocity)

W = Weight of load (lb)

g = Gravitational constant = 386.4 in/sec<sup>2</sup>

r = Radius of gyration (in)

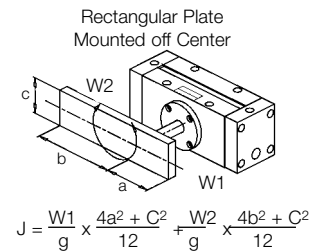
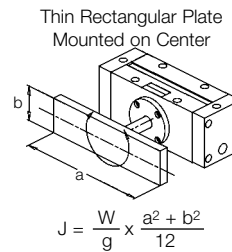
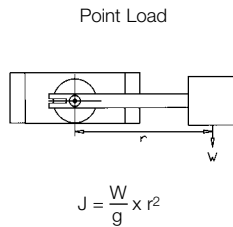
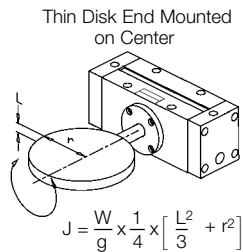
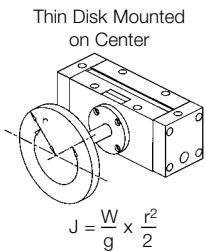

## NuMate Direct Mount, Mounting System

The NuMate mounting system provides a standard series of drilled, tapped and counterbored holes allowing each slide series to mount with each other and other slide series in various combinations without the use of adapter, transition plates or other costly methods. The NuMate mounting system is the most versatile mounting method of its kind, providing customers with a cost effective method of building modular component automation. The NuMate mounting system is consistent across the Numatics Motion Control spectrum of products for automation.

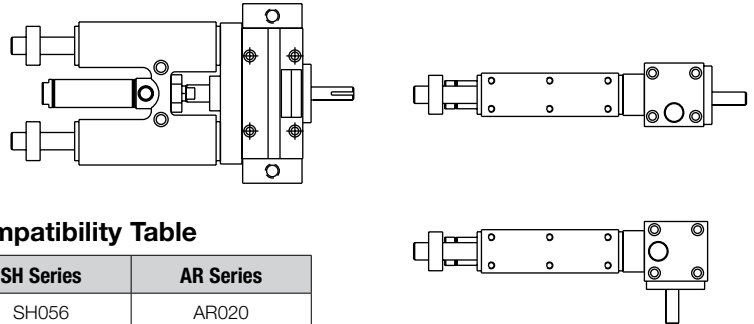

### Compatibility Table

SH Series	AR Series
SH056	AR020
SH075	AR025
SH106	AR032

## AR Series Rotary

Bore	Bracket P/N
AR020	N99-1185
AR025	N99-1185
AR032	N99-1185

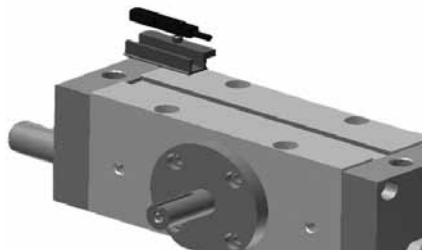

Sensor Description	Standard Cord Set	Quick Disconnect
Reed Switch	REED-FL2-00	REED-QDS-M8U
Hall PNP	PNP-FL2-00-U	PNP-QDS-M8-U
Hall NPN	NPN-FL2-00-U	NPN-QDS-M8-U

See page 8, 9, & 10 for sensor specifications

Sensing Part Numbers

PNP-FL2-00-U

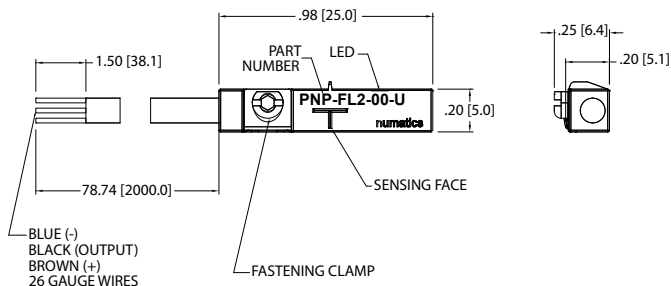

PNP-QDS-M8-U

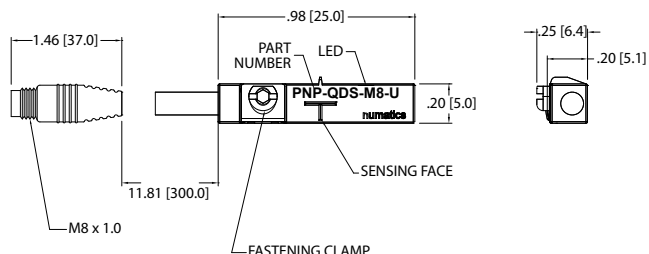

ELECTRICAL DESIGN	DC PNP
OUTPUT	Normally Open
OPERATING VOLTAGE	10-30 VDC
CURRENT RATING	100 mA
SHORT-CIRCUIT PROTECTION	Yes
OVERLOAD PROTECTION	Yes
REVERSE POLARITY PROTECTION	Yes
VOLTAGE DROP	< 2.5 V
CURRENT CONSUMPTION	< 12 mA
REPEATABILITY	< .2mm
POWER-ON DELAY TIME	< 30 ms
SWITCH FREQUENCY	> 3000 Hz
AMBIENT TEMPERATURE	-25°C to 85°C
PROTECTION	IP 67, III
HYSTERESIS	1.0mm
MAGNETIC SENSITIVITY	2.0 mT
TRAVEL SPEED	> 10 m/s
HOUSING MATERIAL	PA (Polyamide) Black; Fastening Clamp: Stainless Steel
FUNCTION DISPLAY SWITCHING STATUS	Yellow LED
CONNECTION	Flying Leads, Pur Cable (2m Long, 3 x26 Gauge Wire)
REMARKS	Clamping Screw with Combined Slot/Hexagon Socket Head AF 1.5 cULus - Class 2 Source Required
ACCESSORIES	Rubber Placeholder, Cable Clip, and Cut Sheet To Be Provided with Every Switch
AGENCY APPROVALS	



ELECTRICAL DESIGN	DC PNP
OUTPUT	Normally Open
OPERATING VOLTAGE	10-30 VDC
CURRENT RATING	100 mA
SHORT-CIRCUIT PROTECTION	Yes
OVERLOAD PROTECTION	Yes
REVERSE POLARITY PROTECTION	Yes
VOLTAGE DROP	< 2.5 V
CURRENT CONSUMPTION	< 12 mA
REPEATABILITY	< .2mm
POWER-ON DELAY TIME	< 30 ms
SWITCH FREQUENCY	> 3000 Hz
AMBIENT TEMPERATURE	-25°C to 85°C
PROTECTION	IP 67, III
HYSTERESIS	1.0mm
MAGNETIC SENSITIVITY	2.0 mT
TRAVEL SPEED	> 10 m/s
HOUSING MATERIAL	PA (Polyamide) Black; Fastening Clamp: Stainless Steel
FUNCTION DISPLAY SWITCHING STATUS	Yellow LED
CONNECTION	M8 Connector (Snap Fit) , Pur Cable (.3 m)
REMARKS	Clamping Screw with Combined Slot/Hexagon Socket Head AF 1.5 cULus - Class 2 Source Required
ACCESSORIES	Rubber Placeholder, Cable Clip, and Cut Sheet To Be Provided with Every Switch
AGENCY APPROVALS	



\*Switches are not designed for wet environments. Please see your distributor for additional information.

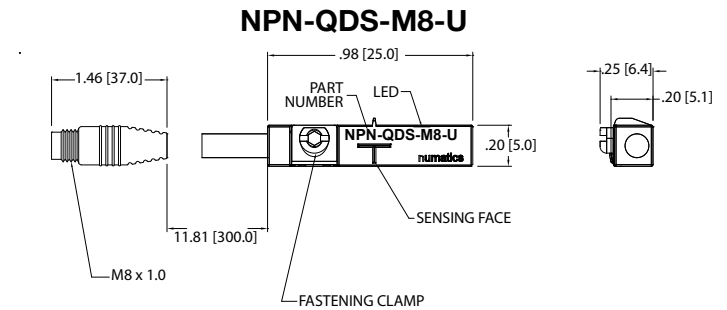
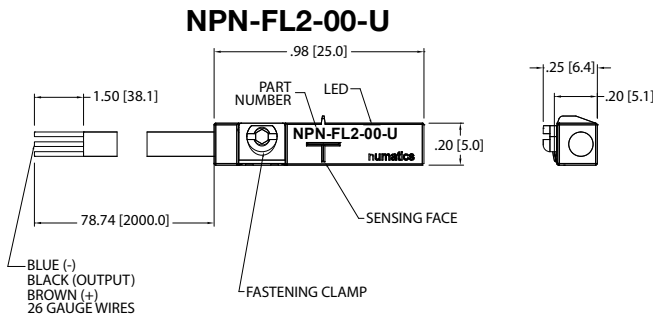

## Sensing Part Numbers



ELECTRICAL DESIGN	DC NPN
OUTPUT	Normally Open
OPERATING VOLTAGE	10-30 VDC
CURRENT RATING	100 mA
SHORT-CIRCUIT PROTECTION	Yes
OVERLOAD PROTECTION	Yes
REVERSE POLARITY PROTECTION	Yes
VOLTAGE DROP	< 2.5 V
CURRENT CONSUMPTION	< 12 mA
REPEATABILITY	< .2mm
POWER-ON DELAY TIME	< 30 ms
SWITCH FREQUENCY	> 3000 Hz
AMBIENT TEMPERATURE	-25°C to 85°C
PROTECTION	IP 67, III
HYSTERESIS	1.0mm
MAGNETIC SENSITIVITY	2.0 mT
TRAVEL SPEED	> 10 m/s
HOUSING MATERIAL	PA (Polyamide) Black; Fastening Clamp: Stainless Steel
FUNCTION DISPLAY SWITCHING STATUS	Yellow LED
CONNECTION	Flying Leads, Pur Cable (2m Long, 3 x26 Gauge Wire)
REMARKS	Clamping Screw with Combined Slot/Hexagon Socket Head AF 1.5 cULus - Class 2 Source Required
ACCESSORIES	Rubber Placeholder, Cable Clip, and Cut Sheet To Be Provided with Every Switch
AGENCY APPROVALS	  

ELECTRICAL DESIGN	DC NPN
OUTPUT	Normally Open
OPERATING VOLTAGE	10-30 VDC
CURRENT RATING	100 mA
SHORT-CIRCUIT PROTECTION	Yes
OVERLOAD PROTECTION	Yes
REVERSE POLARITY PROTECTION	Yes
VOLTAGE DROP	< 2.5 V
CURRENT CONSUMPTION	< 12 mA
REPEATABILITY	< .2mm
POWER-ON DELAY TIME	< 30 ms
SWITCH FREQUENCY	> 3000 Hz
AMBIENT TEMPERATURE	-25°C to 85°C
PROTECTION	IP 67, III
HYSTERESIS	1.0mm
MAGNETIC SENSITIVITY	2.0 mT
TRAVEL SPEED	> 10 m/s
HOUSING MATERIAL	PA (Polyamide) Black; Fastening Clamp: Stainless Steel
FUNCTION DISPLAY SWITCHING STATUS	Yellow LED
CONNECTION	M8 Connector (Snap Fit) , Pur Cable (.3 m)
REMARKS	Clamping Screw with Combined Slot/Hexagon Socket Head AF 1.5 cULus - Class 2 Source Required
ACCESSORIES	Rubber Placeholder, Cable Clip, and Cut Sheet To Be Provided with Every Switch
AGENCY APPROVALS	  

\*Switches are not designed for wet environments. Please see your distributor for additional information.

Sensing Part Numbers

REED-FL2-00

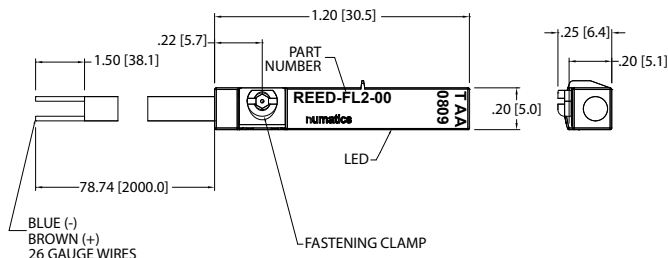

REED-QDS-M8U

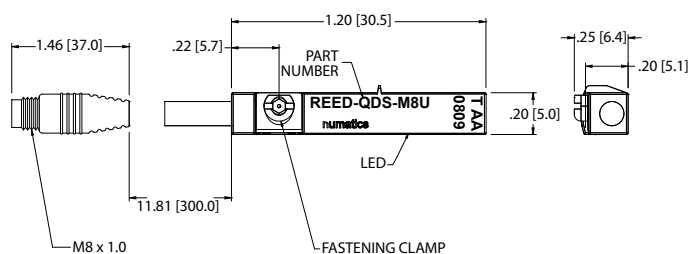

ELECTRICAL DESIGN	AC/DC REED
OUTPUT	Normally Open
OPERATING VOLTAGE	5-120 VAC/DC
CURRENT RATING	100 mA*
SHORT-CIRCUIT PROTECTION	No
OVERLOAD PROTECTION	No
REVERSE POLARITY PROTECTION	Yes
VOLTAGE DROP	< 5 V
REPEATABILITY	± .2mm
MAKETIME INCLUDING BOUNCE	< .6 ms
BREAKTIME	< .1 ms
SWITCHING POWER (MAX)	5 W
SWITCH FREQUENCY	1000 Hz
AMBIENT TEMPERATURE	-25°C to 70°C
PROTECTION	IP 67, II
HYSTERESIS	.9mm
HOUSING MATERIAL	PA (Polyamide) Black; Fastening Clamp: Stainless Steel
FUNCTION DISPLAY SWITCHING STATUS	Yellow LED
CONNECTION	Flying Leads, Pur Cable (2m Long, 2 x26 Gauge Wire)
REMARKS	*External Protective Circuit for Inductive Load (Valve, Contactor, Etc..) Necessary. Conforms to 2008 NEC Section 725 III, Class 2 Circuits  Clamping Screw with Combined Slot/Hexagon Socket Head AF 1.5. No LED Function in case of Polarity in DC Operation
ACCESSORIES	Rubber Placehold, Cable Clip, and Cut Sheet To Be Provided with Every Switch
AGENCY APPROVALS	

ELECTRICAL DESIGN	AC/DC REED
OUTPUT	Normally Open
OPERATING VOLTAGE	*5-60 VDC / 5-50 VAC
CURRENT RATING	100 mA
SHORT-CIRCUIT PROTECTION	No
OVERLOAD PROTECTION	No
REVERSE POLARITY PROTECTION	Yes
VOLTAGE DROP	< 5 V
REPEATABILITY	± .2mm
MAKETIME INCLUDING BOUNCE	< .6 ms
BREAKTIME	< .1 ms
SWITCHING POWER (MAX)	5 W
SWITCH FREQUENCY	1000 Hz
AMBIENT TEMPERATURE	-25°C to 70°C
PROTECTION	IP 67, II
HYSTERESIS	.9mm
HOUSING MATERIAL	PA (Polyamide) Black; Fastening Clamp: Stainless Steel
FUNCTION DISPLAY SWITCHING STATUS	Yellow LED
CONNECTION	M8 Connector (Snap Fit), Pur Cable (.3m)
REMARKS	*External Protective Circuit for Inductive Load (Valve, Contactor, Etc..) Necessary. Conforms to 2008 NEC Section 725 III, Class 2 Circuits  M8 Connector voltage limited to 5-60 vdc / 5-50 vac to conform with 2008 IEC 61076-2-104  Clamping Screw with Combined Slot/Hexagon Socket Head AF 1.5. No LED Function in case of Polarity in DC Operation
ACCESSORIES	Rubber Placehold, Cable Clip, and Cut Sheet To Be Provided with Every Switch
AGENCY APPROVALS	

\*Switches are not designed for wet environments. Please see your distributor for additional information.

## Quick Disconnect Cables

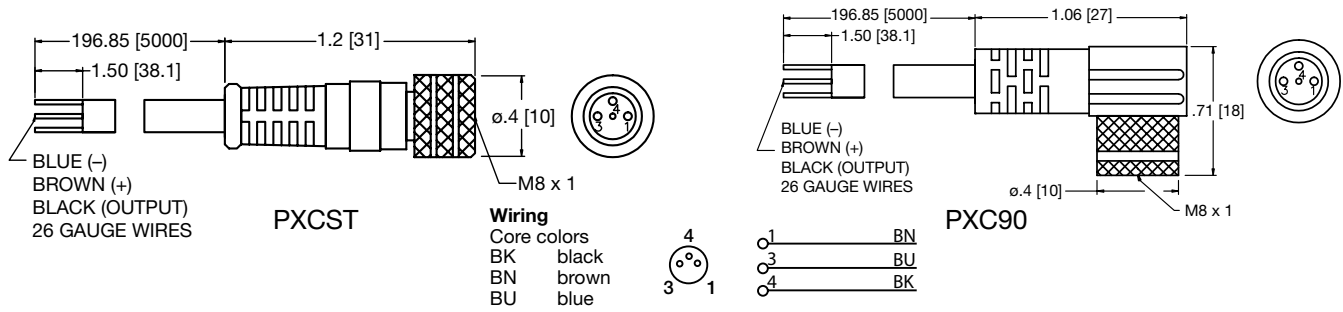

Order Code	Type	Operating Voltage	Current Rating	Cable Material	Protection	Connector
PXCST	Straight 5 m Cable (3 x 26 Gauge wire)	60 AC/75 DC	3 A	PUR	IP 68, III	M8
PXC90	90° 5 m Cable (3 x 26 Gauge wire)	60 AC/75 DC	3 A	PUR	IP 68, III	M8

# NUMATICS®

World Class Supplier of Pneumatic Components



## World Headquarters

### USA Numatics, Incorporated

46280 Dylan Drive  
Novi, Michigan 48377

P: 248-596-3200  
F: 248-596-3201

### Canada Numatics, Ltd

P: 519-758-2700  
F: 519-758-5540

### México - Ascomatica SA de CV

P: 52 55 58 09 56 40 (DF y Area metropolitana)  
P: 01 800 000 ASCO (2726) (Interior de la República)  
F: 52 55 58 09 56 60

### Brazil Ascoval Ind.e Comercio Ltda

P: (55) 11-4208-1700  
F: (55) 11-4195-3970