

NUMATICS®

SC Series

Swing Clamp



www.numatics.com

EMERSON
Industrial Automation

BCAE
Automation Solutions

青岛秉诚自动化设备有限公司
地址：中国·青岛市重庆南路99号海尔云街甲3号楼7F

服务热线：4006-918-365
网址：<http://www.ivalve.cc>

传真：(86-532)585-10-365
Email：sales@bechinas.com

SC Series Swing Clamps

Features and Benefits	3
How To Order	3
Dimensions and Technical Specifications	4
Sensing Part Numbers	5-7
Quick Disconnect Cable	8

Numatics Motion Control SC-Series Swing Clamps combine linear and rotary motions. A specially machined spline internal to the piston rod develops the combined motions. When the clamp is extended, a linear movement first happens. This removes the clamp tooling from the clamped surface so it is not damaged. After completing the linear travel, rotation occurs swinging the clamp arm away from the work holding area. When clamping, the opposite motions occur.

A. Body

Hardcoat anodized aluminum, light weight, durable PTFE impregnated, lubricated, maximizes seal life.

B. Rod Bushing

Large bearing area provides maximum rod support side load protected.

C. Piston Rod

Hardened electroless nickel plated corrosion resistant, durable low wearing surface.

D. Clamp Arm

Taper mounted convenient arm adjustment, 360 degree adjustment.

E. Mounting Surface

Convenient location precision machined to accept standard industrial fasteners.



How to Order

SC 025 A 1 6 D X

Bore Size
 025 = 25 mm
 032 = 32 mm
 040 = 40 mm
 050 = 50 mm
 063 = 63 mm

Arm Rotation
 A = CW
 B = CCW

Clamp Arm
 1 = Single
 2* = Double
 *Not available on SC025.

Special Options
 X = No Options

Sensing Position
 A = Clamp
 B = Unclamp
 C = Clamp and Unclamp
 D = No Sensing
 E = Magnetic Piston - No Sensing

Sensing Type
 Standard Cord Set
 1 = Hall Effect - PNP (sourcing)
 2 = Hall Effect - NPN (sinking)
 3 = Reed Switch
 6 = No Sensing
 Quick Disconnect Cord Set
 Z = Hall Effect - PNP (sourcing)
 Y = Hall Effect - NPN (sinking)
 X = Reed Switch
 See page 5.

Sensing Kits

Standard Cord Set Switch	Part No.
Hall Effect PNP (Sourcing)	PNP-FL2-00-U
Hall Effect NPN (Sinking)	NPN-FL2-00-U
Reed Switch	REED-FL2-00S

Quick Disconnect Cord Set	Part No.
Hall Effect PNP (Sourcing)	PNP-QDS-M8-U
Hall Effect NPN (Sinking)	NPN-QDS-M8-U
Reed Switch	REED-QDS-M8S
90° 5 meter cable	PXC90
Straight 5 meter cable	PXCST

Dimensions: Inches (mm)

SC Series

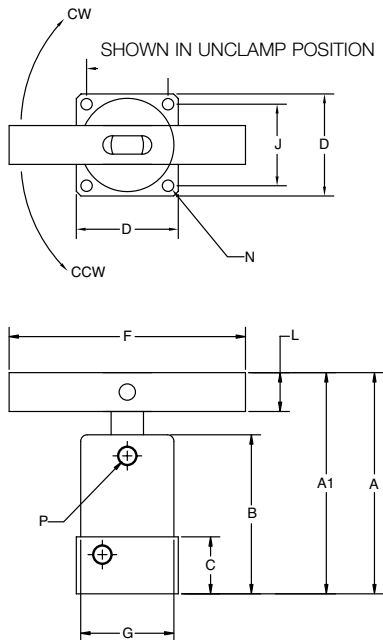
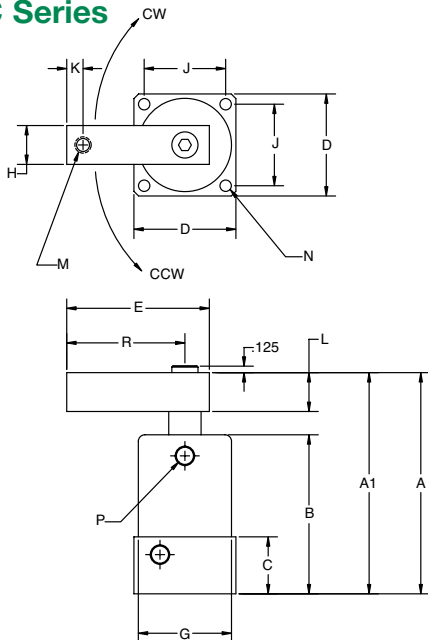

SC025 WITH SENSING MAGNET ONLY

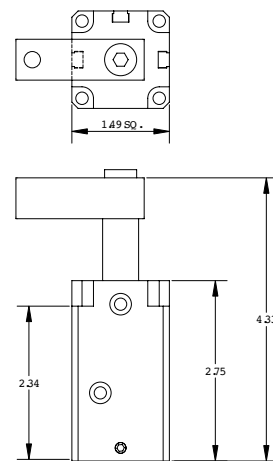

Model	Retract A*	Extend A1*	B*	C	D	E	F	G	H	J	K	L	M	N	P	R
SC025**	3.27 (83.0)	4.13 (105.0)	2.55 (65.0)	0.90 (23.0)	1.49 (38.0)	1.96 (50.0)	-	1.37 (35.0)	.62 (15.9)	1.18 (30.0)	0.25 (6.5)	0.62 (15.9)	M6	.18 (4.7)	M5	1.61 (41.0)
SC032	4.00 (101.0)	5.00 (127.0)	3.07 (78.0)	1.10 (28.0)	1.96 (50.0)	2.75 (70.0)	5.51 (140.0)	1.81 (46.0)	0.74 (19.0)	1.57 (40.0)	0.31 (8.0)	0.74 (19.0)	M8	.22 (5.7)	G1/8	2.24 (57.0)
SC040	4.00 (101.0)	5.00 (127.0)	3.07 (78.0)	1.10 (28.0)	2.36 (60.0)	2.95 (75.0)	5.51 (140.0)	2.16 (55.0)	0.74 (19.0)	1.89 (48.0)	0.31 (8.0)	0.74 (19.0)	M8	.27 (6.8)	G1/8	2.46 (63.5)
SC050	4.70 (119.5)	5.89 (149.5)	3.56 (90.5)	1.22 (31.0)	2.75 (70.0)	3.34 (85.0)	6.30 (160.0)	2.55 (65.0)	1.00 (25.4)	2.24 (57.0)	0.39 (10.0)	1.00 (25.4)	M10	.27 (6.8)	G1/8	2.76 (70.0)
SC063	4.70 (119.5)	5.89 (149.5)	3.56 (90.5)	1.22 (31.0)	3.25 (83.0)	3.74 (95.0)	6.30 (160.0)	3.07 (78.0)	1.00 (25.4)	2.64 (67.0)	0.39 (10.0)	1.00 (25.4)	M10	.35 (9.0)	G1/8	3.15 (80.0)

*With sensing magnet add 0.200 in.

**SC025 with Sensing magnet includes 4 M4 x 70mm SHCS for mounting.

Model	Bore Size	Clamp Force	Clamp Force	Total Stroke	Clamping Stroke	Swing Stroke	Max. M2 Moment
SC025	25mm	52 lbs.	231 N	0.86 in. (22.0 mm)	0.43 in. (11.0 mm)	0.43 in. (11.0 mm)	101.0 in.-lb. (6.2 Nm)
SC032	32mm	93 lbs.	413 N	1.02 in. (26.0 mm)	0.51 in. (13.0 mm)	0.51 in. (13.0 mm)	266 in.-lb. (16.3 Nm)
SC040	40mm	163 lbs.	726 N	1.02 in. (26.0 mm)	0.51 in. (13.0 mm)	0.51 in. (13.0 mm)	402.0 in.-lb. (24.7 Nm)
SC050	50mm	255 lbs.	1134 N	1.18 in. (30.0 mm)	0.59 in. (15.0 mm)	0.59 in. (15.0 mm)	700.0 in.-lb. (43.0 Nm)
SC063	63mm	434 lbs.	1930 N	1.18 in. (30.0 mm)	0.59 in. (15.0 mm)	0.59 in. (15.0 mm)	1300.0 in.-lb. (79.9 Nm)

SC Series Swing Clamp

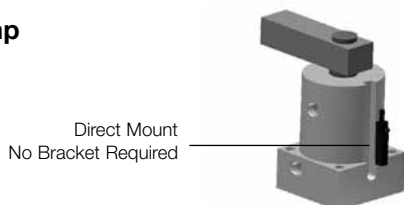

Sensor Description	Standard Cord Set	Quick Disconnect
Reed Switch	REED-FL2-00S	REED-QDS-M8S
Hall PNP	PNP-FL2-00-U	PNP-QDS-M8-U
Hall NPN	NPN-FL2-00-U	NPN-QDS-M8-U

See page 5, 6, & 7 for sensor specifications

Sensing Part Numbers

PNP-FL2-00-U

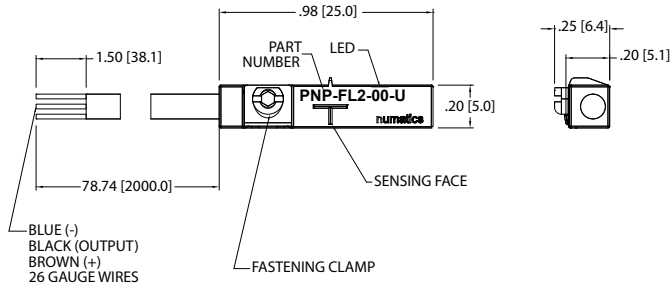

PNP-QDS-M8-U

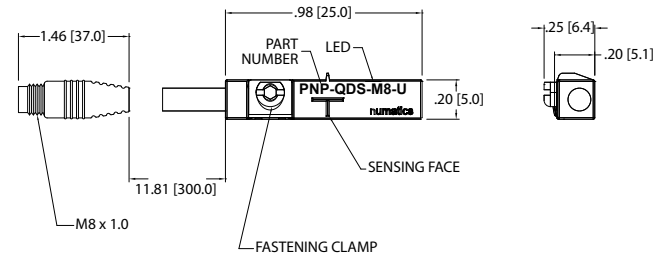

ELECTRICAL DESIGN	DC PNP
OUTPUT	Normally Open
OPERATING VOLTAGE	10-30 VDC
CURRENT RATING	100 mA
SHORT-CIRCUIT PROTECTION	Yes
OVERLOAD PROTECTION	Yes
REVERSE POLARITY PROTECTION	Yes
VOLTAGE DROP	< 2.5 V
CURRENT CONSUMPTION	< 12 mA
REPEATABILITY	< .2mm
POWER-ON DELAY TIME	< 30 ms
SWITCH FREQUENCY	> 3000 Hz
AMBIENT TEMPERATURE	-25°C to 85°C
PROTECTION	IP 67, III
HYSTERESIS	1.0mm
MAGNETIC SENSITIVITY	2.0 mT
TRAVEL SPEED	> 10 m/s
HOUSING MATERIAL	PA (Polyamide) Black; Fastening Clamp: Stainless Steel
FUNCTION DISPLAY SWITCHING STATUS	Yellow LED
CONNECTION	Flying Leads, Pur Cable (2m Long, 3 x26 Gauge Wire)
REMARKS	Clamping Screw with Combined Slot/Hexagon Socket Head AF 1.5 cULus - Class 2 Source Required
ACCESSORIES	Rubber Placeholder, Cable Clip, and Cut Sheet To Be Provided with Every Switch
AGENCY APPROVALS	

ELECTRICAL DESIGN	DC PNP
OUTPUT	Normally Open
OPERATING VOLTAGE	10-30 VDC
CURRENT RATING	100 mA
SHORT-CIRCUIT PROTECTION	Yes
OVERLOAD PROTECTION	Yes
REVERSE POLARITY PROTECTION	Yes
VOLTAGE DROP	< 2.5 V
CURRENT CONSUMPTION	< 12 mA
REPEATABILITY	< .2mm
POWER-ON DELAY TIME	< 30 ms
SWITCH FREQUENCY	> 3000 Hz
AMBIENT TEMPERATURE	-25°C to 85°C
PROTECTION	IP 67, III
HYSTERESIS	1.0mm
MAGNETIC SENSITIVITY	2.0 mT
TRAVEL SPEED	> 10 m/s
HOUSING MATERIAL	PA (Polyamide) Black; Fastening Clamp: Stainless Steel
FUNCTION DISPLAY SWITCHING STATUS	Yellow LED
CONNECTION	M8 Connector (Snap Fit) , Pur Cable (.3 m)
REMARKS	Clamping Screw with Combined Slot/Hexagon Socket Head AF 1.5 cULus - Class 2 Source Required
ACCESSORIES	Rubber Placeholder, Cable Clip, and Cut Sheet To Be Provided with Every Switch
AGENCY APPROVALS	

*Switches are not designed for wet environments. Please see your distributor for additional information.

Sensing Part Numbers

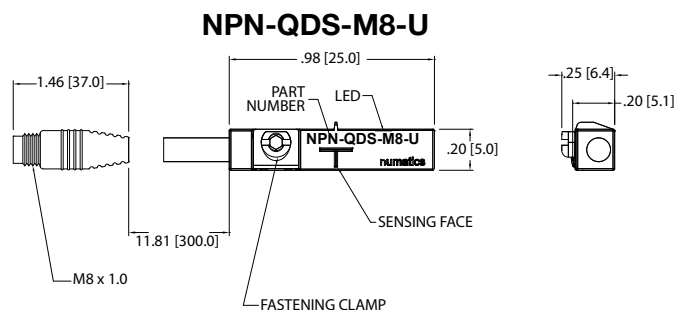
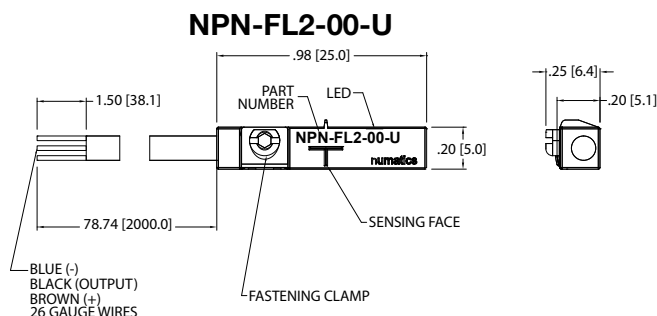

ELECTRICAL DESIGN	DC NPN
OUTPUT	Normally Open
OPERATING VOLTAGE	10-30 VDC
CURRENT RATING	100 mA
SHORT-CIRCUIT PROTECTION	Yes
OVERLOAD PROTECTION	Yes
REVERSE POLARITY PROTECTION	Yes
VOLTAGE DROP	< 2.5 V
CURRENT CONSUMPTION	< 12 mA
REPEATABILITY	< .2mm
POWER-ON DELAY TIME	< 30 ms
SWITCH FREQUENCY	> 3000 Hz
AMBIENT TEMPERATURE	-25°C to 85°C
PROTECTION	IP 67, III
HYSTERESIS	1.0mm
MAGNETIC SENSITIVITY	2.0 mT
TRAVEL SPEED	> 10 m/s
HOUSING MATERIAL	PA (Polyamide) Black; Fastening Clamp: Stainless Steel
FUNCTION DISPLAY SWITCHING STATUS	Yellow LED
CONNECTION	Flying Leads, Pur Cable (2m Long, 3 x26 Gauge Wire)
REMARKS	Clamping Screw with Combined Slot/Hexagon Socket Head AF 1.5 cULus - Class 2 Source Required
ACCESSORIES	Rubber Placeholder, Cable Clip, and Cut Sheet To Be Provided with Every Switch
AGENCY APPROVALS	

ELECTRICAL DESIGN	DC NPN
OUTPUT	Normally Open
OPERATING VOLTAGE	10-30 VDC
CURRENT RATING	100 mA
SHORT-CIRCUIT PROTECTION	Yes
OVERLOAD PROTECTION	Yes
REVERSE POLARITY PROTECTION	Yes
VOLTAGE DROP	< 2.5 V
CURRENT CONSUMPTION	< 12 mA
REPEATABILITY	< .2mm
POWER-ON DELAY TIME	< 30 ms
SWITCH FREQUENCY	> 3000 Hz
AMBIENT TEMPERATURE	-25°C to 85°C
PROTECTION	IP 67, III
HYSTERESIS	1.0mm
MAGNETIC SENSITIVITY	2.0 mT
TRAVEL SPEED	> 10 m/s
HOUSING MATERIAL	PA (Polyamide) Black; Fastening Clamp: Stainless Steel
FUNCTION DISPLAY SWITCHING STATUS	Yellow LED
CONNECTION	M8 Connector (Snap Fit) , Pur Cable (.3 m)
REMARKS	Clamping Screw with Combined Slot/Hexagon Socket Head AF 1.5 cULus - Class 2 Source Required
ACCESSORIES	Rubber Placeholder, Cable Clip, and Cut Sheet To Be Provided with Every Switch
AGENCY APPROVALS	

*Switches are not designed for wet environments. Please see your distributor for additional information.

Sensing Part Numbers

REED-FL2-00S

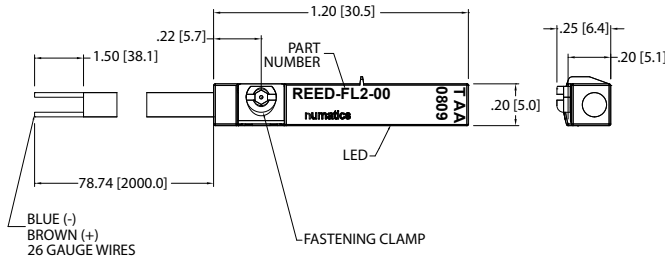

REED-QDS-M8S

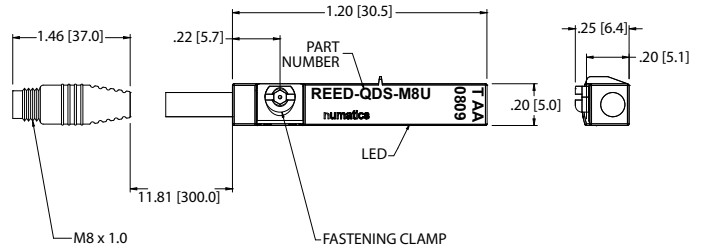

ELECTRICAL DESIGN	AC/DC REED
OUTPUT	Normally Open
OPERATING VOLTAGE	5-120 VAC/DC
CURRENT RATING	100 mA*
SHORT-CIRCUIT PROTECTION	No
OVERLOAD PROTECTION	No
REVERSE POLARITY PROTECTION	Yes
VOLTAGE DROP	< 5 V
REPEATABILITY	± .2mm
MAKETIME INCLUDING BOUNCE	< .6 ms
BREAKTIME	< .1 ms
SWITCHING POWER (MAX)	5 W
SWITCH FREQUENCY	1000 Hz
AMBIENT TEMPERATURE	-25°C to 70°C
PROTECTION	IP 67, II
HYSTERESIS	.9mm
HOUSING MATERIAL	PA (Polyamide) Black; Fastening Clamp: Stainless Steel
FUNCTION DISPLAY SWITCHING STATUS	Yellow LED
CONNECTION	Flying Leads, Pur Cable (2m Long, 2 x26 Gauge Wire)
REMARKS	*External Protective Circuit for Inductive Load (Valve, Contactor, Etc..) Necessary. Conforms to 2008 NEC Section 725 III, Class 2 Circuits Clamping Screw with Combined Slot/Hexagon Socket Head AF 1.5. No LED Function in case of Polarity in DC Operation
ACCESSORIES	Rubber Placeholder, Cable Clip, and Cut Sheet To Be Provided with Every Switch
AGENCY APPROVALS	CE RoHS

ELECTRICAL DESIGN	AC/DC REED
OUTPUT	Normally Open
OPERATING VOLTAGE	*5-60 VDC / 5-50 VAC
CURRENT RATING	100 mA
SHORT-CIRCUIT PROTECTION	No
OVERLOAD PROTECTION	No
REVERSE POLARITY PROTECTION	Yes
VOLTAGE DROP	< 5 V
REPEATABILITY	± .2mm
MAKETIME INCLUDING BOUNCE	< .6 ms
BREAKTIME	< .1 ms
SWITCHING POWER (MAX)	5 W
SWITCH FREQUENCY	1000 Hz
AMBIENT TEMPERATURE	-25°C to 70°C
PROTECTION	IP 67, II
HYSTERESIS	.9mm
HOUSING MATERIAL	PA (Polyamide) Black; Fastening Clamp: Stainless Steel
FUNCTION DISPLAY SWITCHING STATUS	Yellow LED
CONNECTION	M8 Connector (Snap Fit), Pur Cable (.3m)
REMARKS	*External Protective Circuit for Inductive Load (Valve, Contactor, Etc..) Necessary. Conforms to 2008 NEC Section 725 III, Class 2 Circuits M8 Connector voltage limited to 5-60 vdc / 5-50 vac to conform with 2008 IEC 61076-2-104 Clamping Screw with Combined Slot/Hexagon Socket Head AF 1.5. No LED Function in case of Polarity in DC Operation
ACCESSORIES	Rubber Placeholder, Cable Clip, and Cut Sheet To Be Provided with Every Switch
AGENCY APPROVALS	CE RoHS

*Switches are not designed for wet environments. Please see your distributor for additional information.

Quick Disconnect Cables

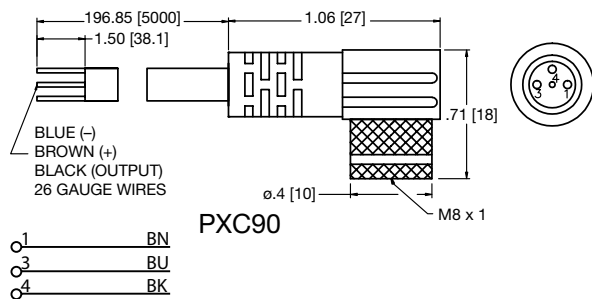
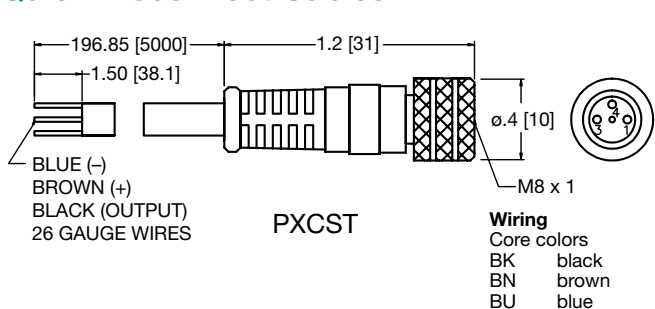

Order Code	Type	Operating Voltage	Current Rating	Cable Material	Protection	Connector
PXCST	Straight 5 m Cable (3 x 26 Gauge wire)	60 AC/75 DC	3 A	PUR	IP 68, III	M8
PXC90	90° 5 m Cable (3 x 26 Gauge wire)	60 AC/75 DC	3 A	PUR	IP 68, III	M8

NUMATICS®

World Class Supplier of Pneumatic Components



World Headquarters

USA Numatics, Incorporated

46280 Dylan Drive
Novi, Michigan 48377

P: 248-596-3200
F: 248-596-3201

Canada Numatics, Ltd

P: 519-758-2700
F: 519-758-5540

México - Ascomatica SA de CV

P: 52 55 58 09 56 40 (DF y Area metropolitana)
P: 01 800 000 ASCO (2726) (Interior de la República)
F: 52 55 58 09 56 60

Brazil Ascoval Ind.e Comercio Ltda

P: (55) 11-4208-1700
F: (55) 11-4195-3970