

NUMATICS®

WBG Series

Wide Body Grippers

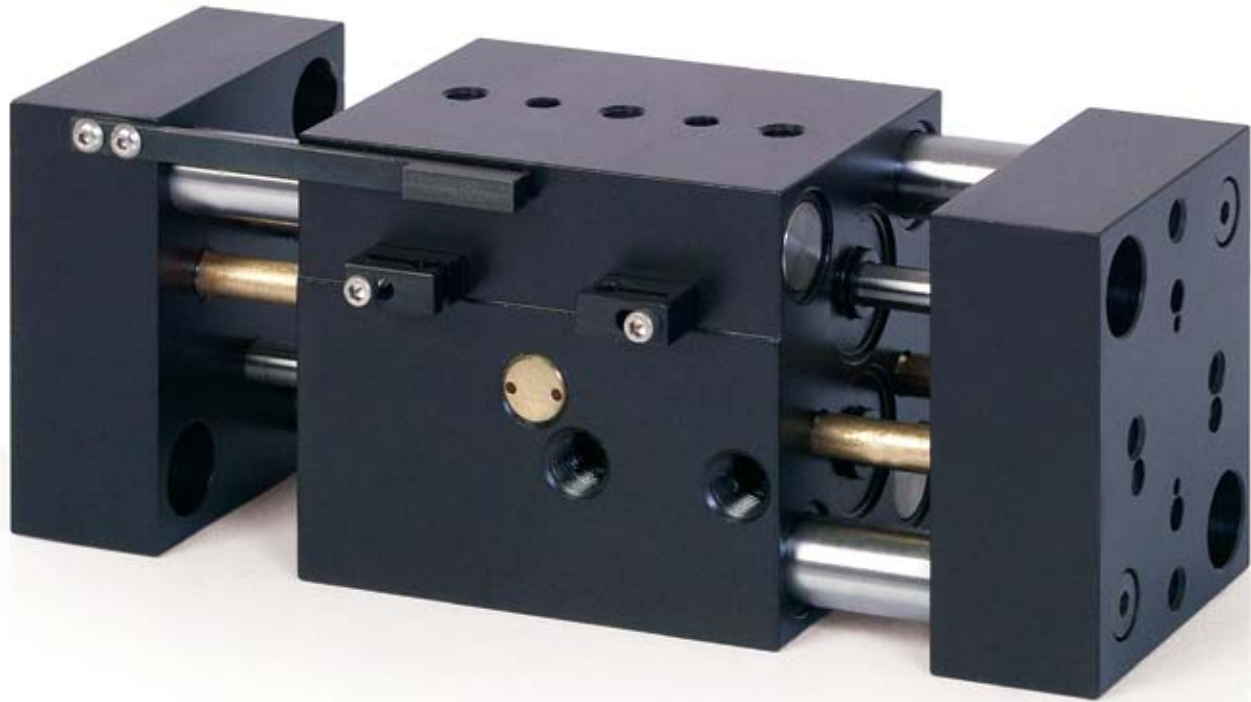

www.numatics.com

EMERSON
Industrial Automation

BCAE
Automation Solutions

青岛秉诚自动化设备有限公司
地址：中国·青岛市重庆南路99号海尔云街甲3号楼7F

服务热线：4006-918-365
网址：<http://www.ivalve.cc>

传真：(86-532)585-10-365
Email：sales@bechinas.com

WBG Series Parallel Grippers

Features and Benefits	3
How To Order	3
WBG 60 Dimensions & Technical Specifications	4
WBG 90 Dimensions & Technical Specifications	5
WBGL 90 Dimensions & Technical Specifications	6
WBGX 90 Dimensions & Technical Specifications	7
WBG 200 Dimensions & Technical Specifications	8
WBGL 200 Dimensions & Technical Specifications	9
WBGX 200 Dimensions & Technical Specifications	10
WBG 300 Dimensions & Technical Specifications	11
WBGL 300 Dimensions & Technical Specifications	12
WBGX 300 Dimensions & Technical Specifications	13
Switches	14
Quick Disconnect Cables	15

Gripper Summary of Operation

WBG-Series utilizes four independent pistons to power the jaws open and closed. Jaws utilize a rack and pinion for synchronization which are independent from force rods and support rods. Non-Synchronous operation is available.

A. Body

High Strength, Anodized aluminum.
Ultra high gripping force to weight ratio.

B. Support rods

Hardened steel support shafts are guided through the full width of the body. Wiper seals assist in keeping rods free of debris.

C. Seals

Piston seals are quad ring type for long service life.

- Pre-lubricated with our specially formulated oil based compound for extensive maintenance free performance.
- Proximity switches are available to monitor open and closed position of the jaws.

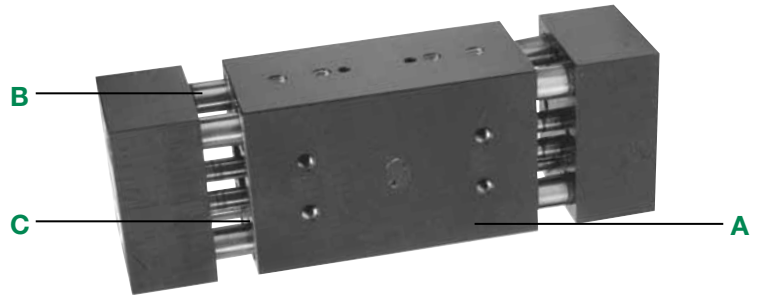

How to Order

<p>Gripper Stroke</p> <p>S = Short L = Long X* = Extra Long *Only available in WBG 90 Series.</p> <p>Gripper Model Number</p> <p>60 90 200 300</p> <p>Gripper Motion</p> <p>S = Synchronous C = Compliant</p> <p>Seal Type</p> <p>1 = Buna-N 2 = FKM</p>	<p>WBG S 60 S 1 W C X</p>	<p>Options</p> <p>X = Standard</p> <p>Sensing Position</p> <p>A = Single Position Open B = Single Position Closed C = Two Position Sensing D = No Sensing</p> <p>Sensing Type</p> <p>Standard Cord Set 4 = Prox Switch - PNP (sourcing) 5 = Prox Switch - NPN (sinking) 6 = No Sensing Quick Disconnect Cord Set W = Prox Switch - PNP (sourcing) Straight V = Prox Switch - NPN (sinking) Straight U = Prox Switch - PNP (sourcing) 90 Deg. T = Prox Switch - NPN (sinking) 90 Deg. Prox switches are 4 mm diameter.</p>
--	----------------------------------	--

When ordering additional switches:

Switch Description	Standard Part No.	Quick Disconnect Part No.
Prox Switch - PNP (Sourcing)	PROX-4FL2-P	PROX-4QDS-P
Prox Switch - NPN (Sinking)	PROX-4FL2-N	Not Available
Quick disconnect cable straight	-	PXCST
Quick disconnect cable 90 deg.	-	PXC90

Dimensions: Inches

WBG 60 Series

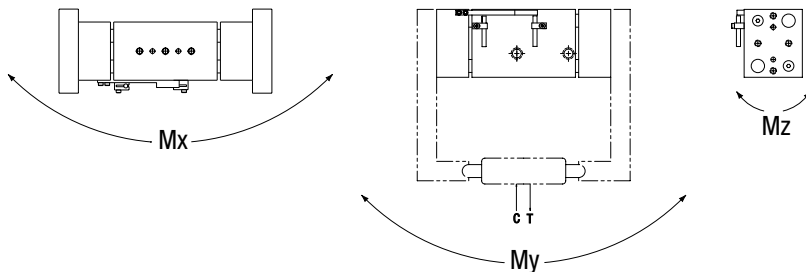
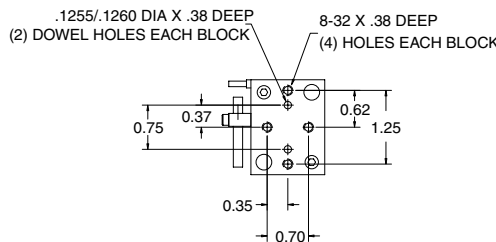
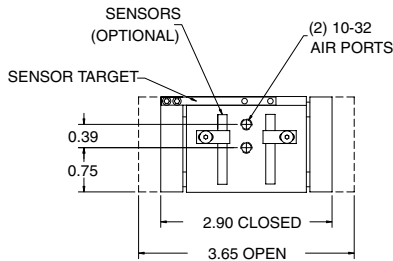
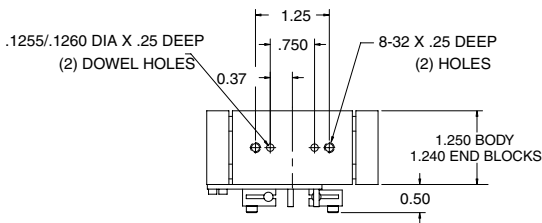
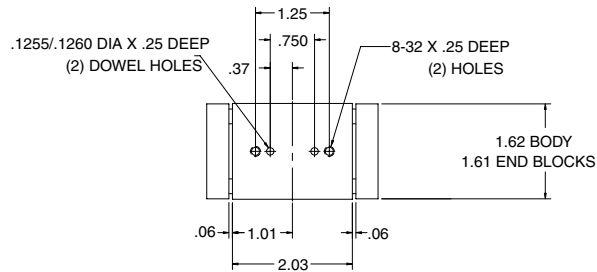

Specifications

Load Capacity	WBG60
Grip Force @ 100 psi	60 lbs
Stroke	0.75
Repeatability	+/- .001
Operating Temp.	
Buna-N	-30° to 180°F
FKM	-20° to 350°F
Max. Actuation Speed	0.3 sec
Displacement	0.29 cu. in.
Maximum Pressure	120 psi
Unit Weight	11 oz

Static Condition

Load Capacity	WBG60
C-compression	50 lbs.
T-tension	50 lbs.
Mx	100 in.-lbs.
My	150 in.-lbs.
Mz	100 in.-lbs.

Dynamic Condition

Load Capacity	WBG60
C-compression	10 lbs.
T-tension	10 lbs.
Mx	20 in.-lbs.
My	30 in.-lbs.
Mz	20 in.-lbs.

**WBG-60
Gripping Force Chart
Per Finger @ 80 psi**

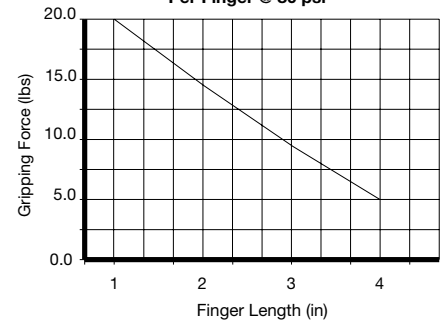

Dimensions: Inches (mm)

WBGs 90 Series

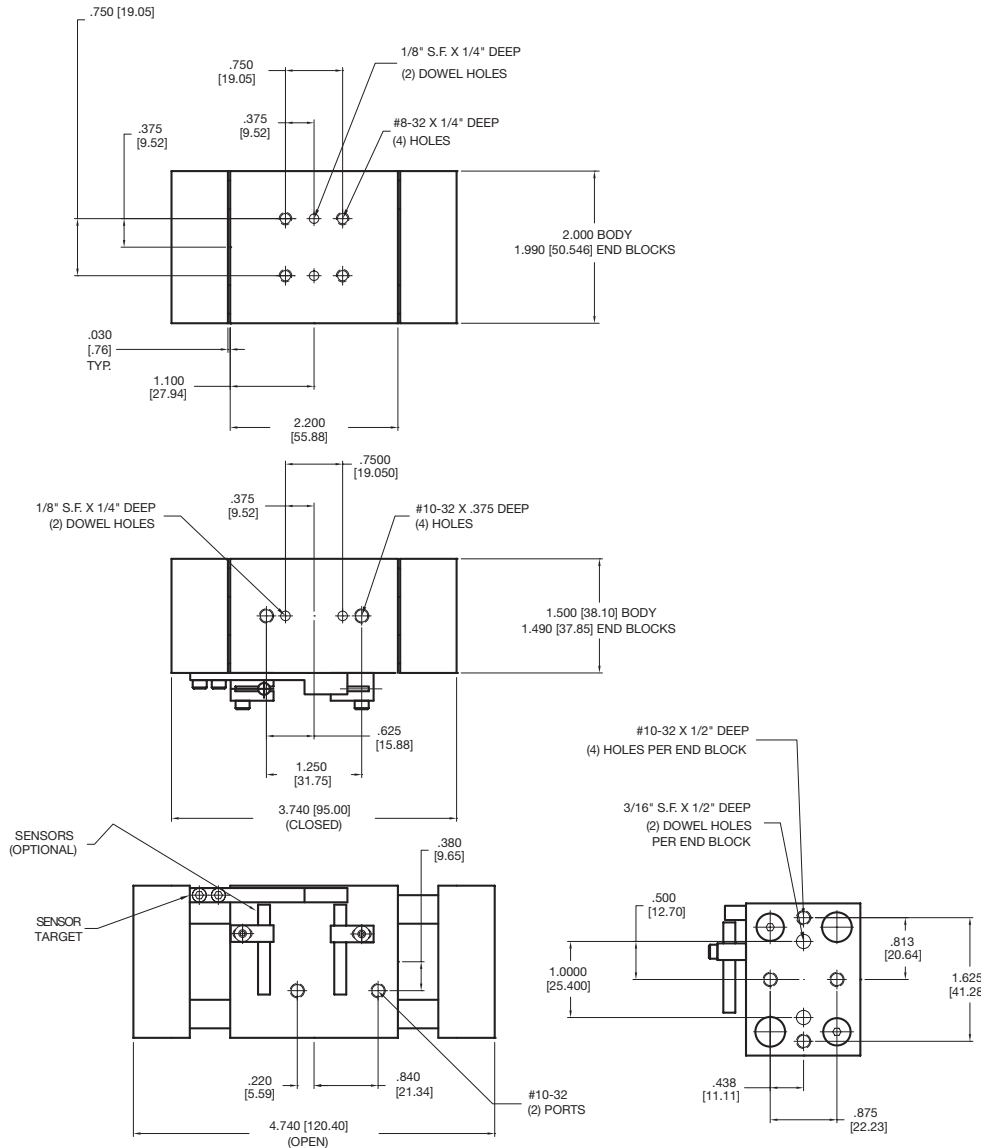

Specifications

Load Capacity	WBGs90
Grip Force @ 80 psi	36 lbs
Stroke	1 in.
Repeatability	+/- 0.002
Operating Temp.	-20°/180°F
Max. Actuation Speed	0.3 sec
Maximum Pressure	120 psi
Unit Weight	1.3 lbs

Static Condition

Load Capacity	WBGs90
C-compression	100 lbs.
T-tension	100 lbs.
Mx	175 in.-lbs.
My	250 in.-lbs.
Mz	175 in.-lbs.

Dynamic Condition

Load Capacity	WBGs90
C-compression	20 lbs.
T-tension	20 lbs.
Mx	35 in.-lbs.
My	50 in.-lbs.
Mz	35 in.-lbs.

WBGs-90

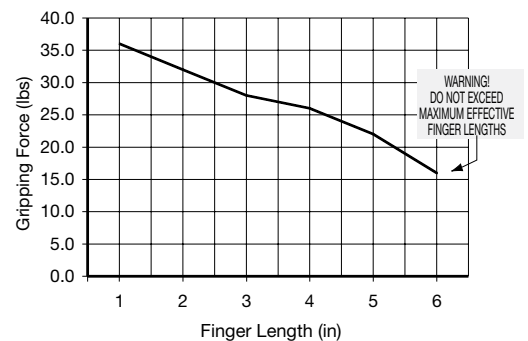

Dimensions: Inches (mm)

WBGL 90 Series

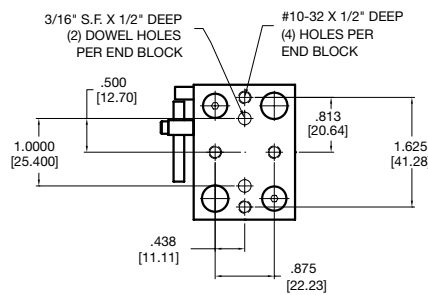
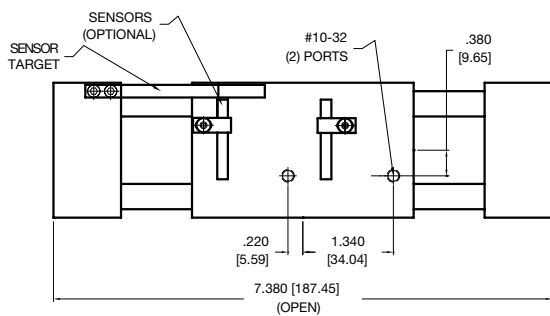
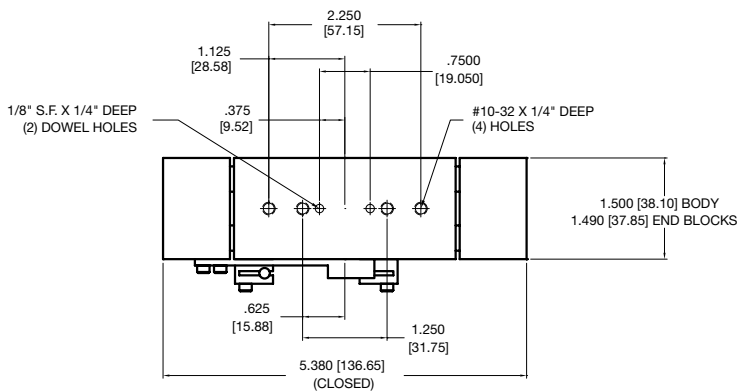
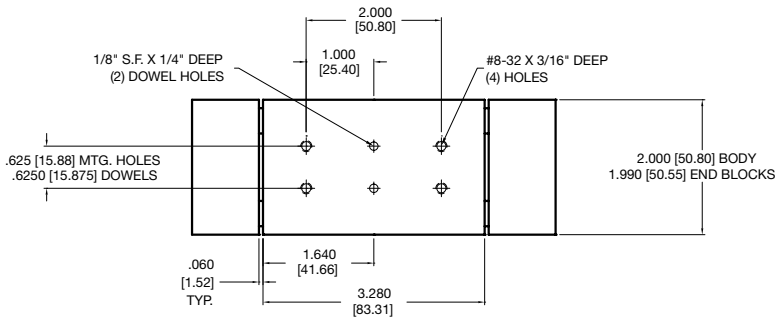

Specifications

Load Capacity	WBGL90
Grip Force @ 80 psi	36 lbs
Stroke	2 in.
Repeatability	+/- 0.002
Operating Temp.	-20°/180°F
Max. Actuation Speed	0.3 sec
Maximum Pressure	120 psi
Unit Weight	2 lbs

Static Condition

Load Capacity	WBGL90
C-compression	100 lbs.
T-tension	100 lbs.
Mx	175 in.-lbs.
My	250 in.-lbs.
Mz	175 in.-lbs.

Dynamic Condition

Load Capacity	WBGL90
C-compression	20 lbs.
T-tension	20 lbs.
Mx	35 in.-lbs.
My	50 in.-lbs.
Mz	35 in.-lbs.

WBGL-90

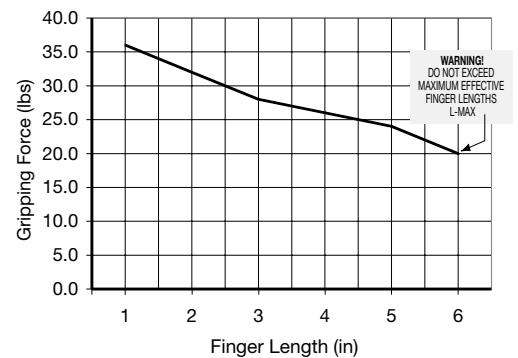

Dimensions: Inches (mm)

WBGX 90 Series

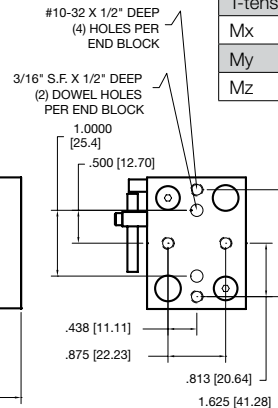
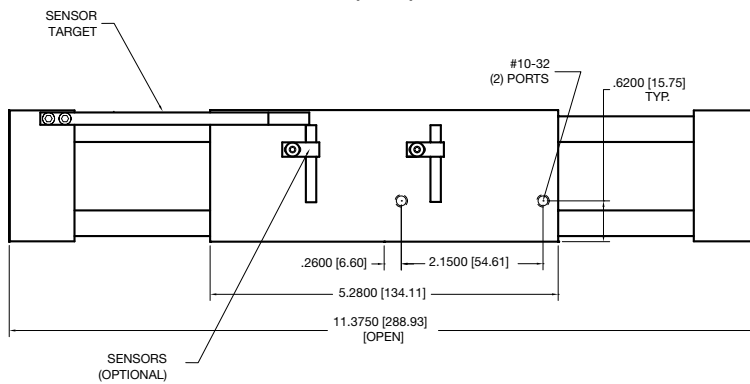
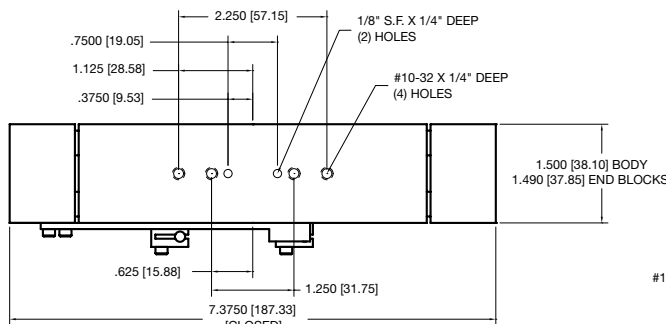
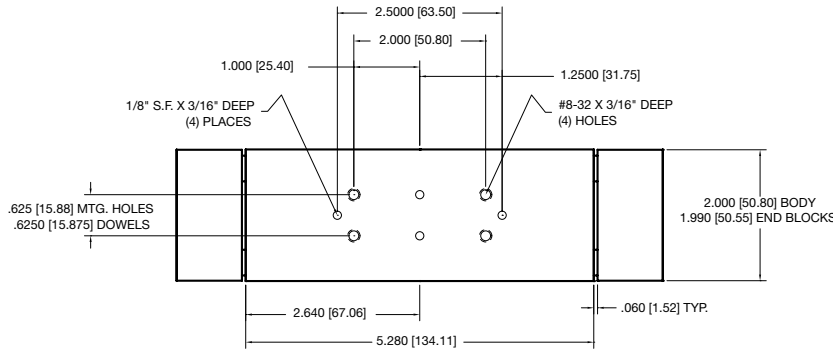

Specifications

Load Capacity	WBGX90
Grip Force @ 80 psi	36 lbs
Stroke	4 in.
Repeatability	+/- 0.002
Operating Temp.	-20°/180°F
Max. Actuation Speed	0.6 sec
Maximum Pressure	120 psi
Unit Weight	3.2 lbs

Static Condition

Load Capacity	WBGX90
C-compression	100 lbs.
T-tension	100 lbs.
Mx	175 in.-lbs.
My	250 in.-lbs.
Mz	175 in.-lbs.

Dynamic Condition

Load Capacity	WBGX90
C-compression	20 lbs.
T-tension	20 lbs.
Mx	35 in.-lbs.
My	50 in.-lbs.
Mz	35 in.-lbs.

WBGX-90

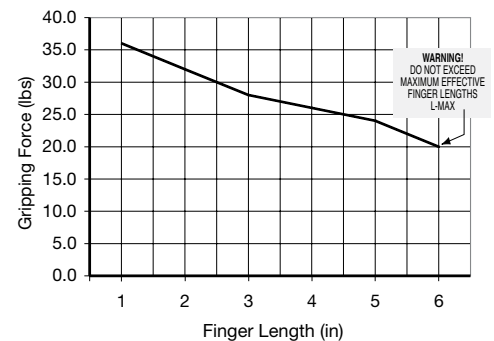

Dimensions: Inches (mm)

WBG S 200 Series

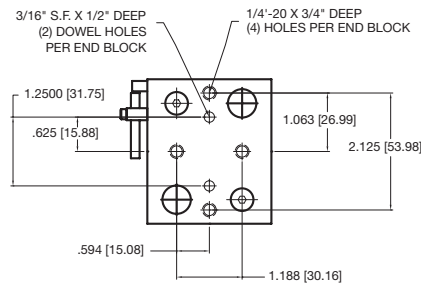
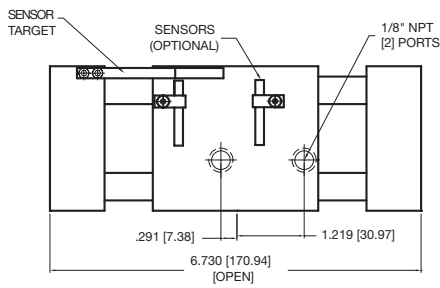
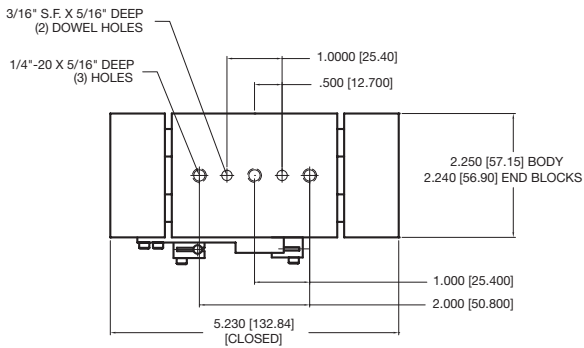
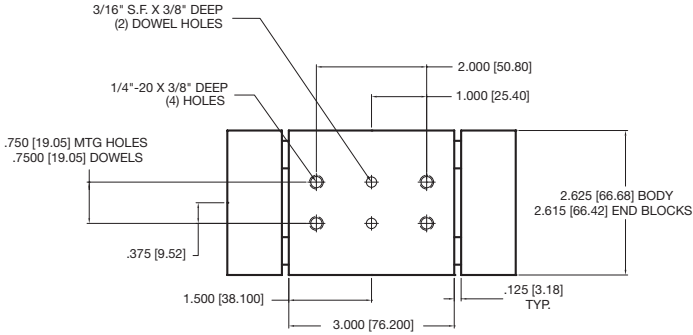

Specifications

Load Capacity	WBG S200
Grip Force @ 80 psi	84 lbs
Stroke	1.5 in.
Repeatability	+/- 0.002
Operating Temp.	-20°/180°F
Max. Actuation Speed	0.3 sec
Maximum Pressure	120 psi
Unit Weight	3 lbs

Static Condition

Load Capacity	WBG S200
C-compression	500 lbs.
T-tension	500 lbs.
Mx	500 in.-lbs.
My	750 in.-lbs.
Mz	500 in.-lbs.

Dynamic Condition

Load Capacity	WBG S200
C-compression	50 lbs.
T-tension	50 lbs.
Mx	50 in.-lbs.
My	75 in.-lbs.
Mz	50 in.-lbs.

WBG S-200

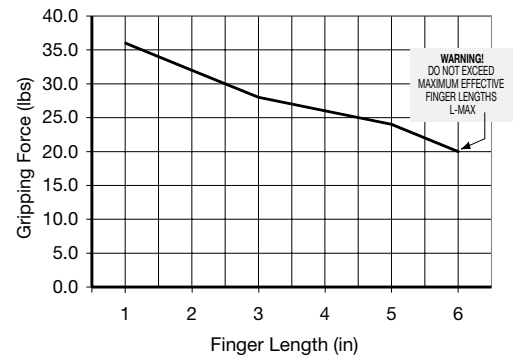

Dimensions: Inches (mm)

WBGL 200 Series

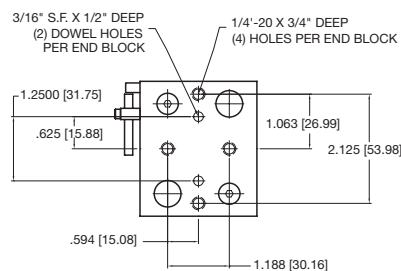
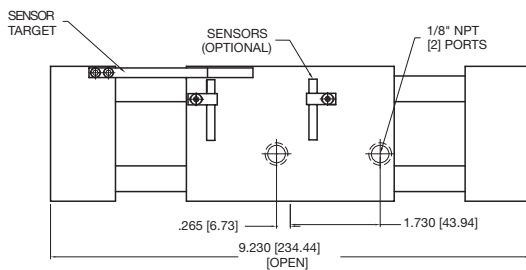
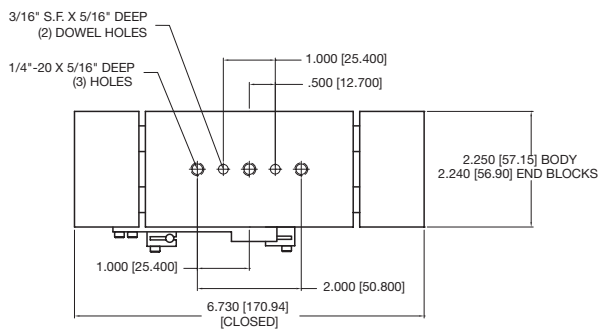
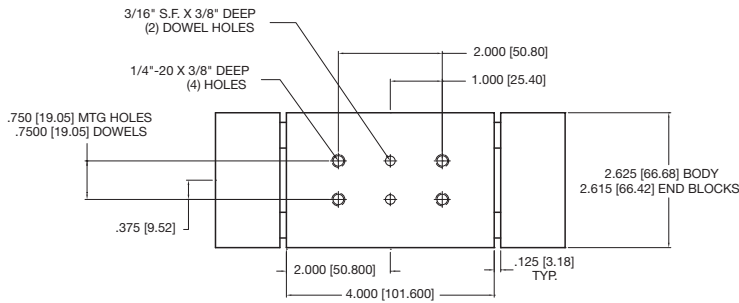

Specifications

Load Capacity	WBGL200
Grip Force @ 80 psi	84 lbs
Stroke	2.5 in.
Repeatability	+/- 0.002
Operating Temp.	-20°/180°F
Max. Actuation Speed	0.3 sec
Maximum Pressure	120 psi
Unit Weight	4 lbs

Static Condition

Load Capacity	WBGL200
C-compression	500 lbs.
T-tension	500 lbs.
Mx	500 in.-lbs.
My	750 in.-lbs.
Mz	500 in.-lbs.

Dynamic Condition

Load Capacity	WBGL200
C-compression	50 lbs.
T-tension	50 lbs.
Mx	50 in.-lbs.
My	75 in.-lbs.
Mz	50 in.-lbs.

WBGL-200

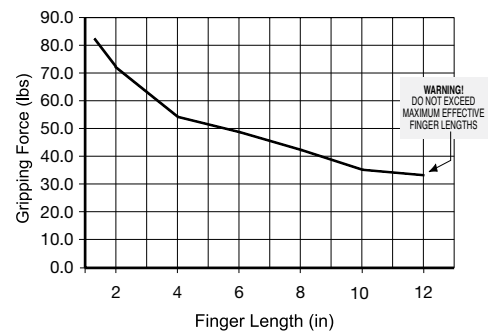

Dimensions: Inches (mm)

WBGX 200 Series

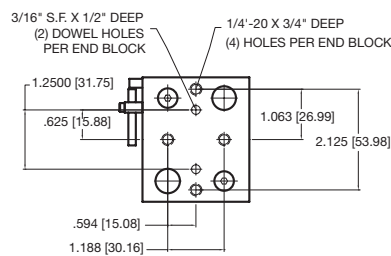
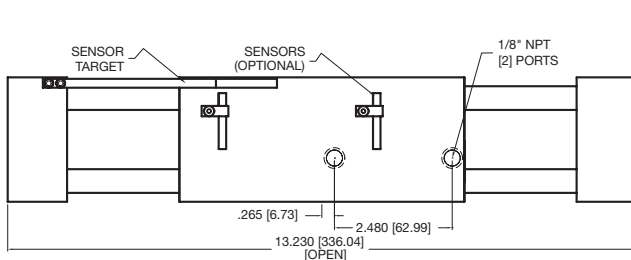
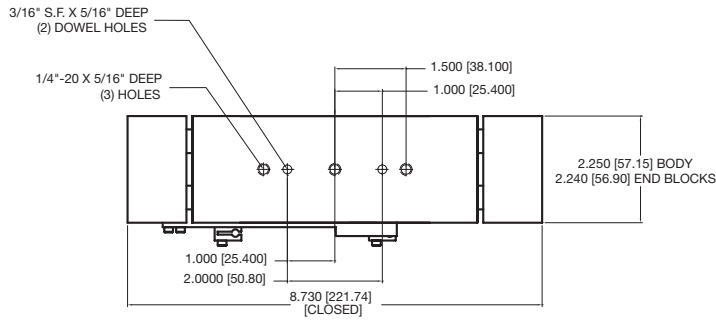
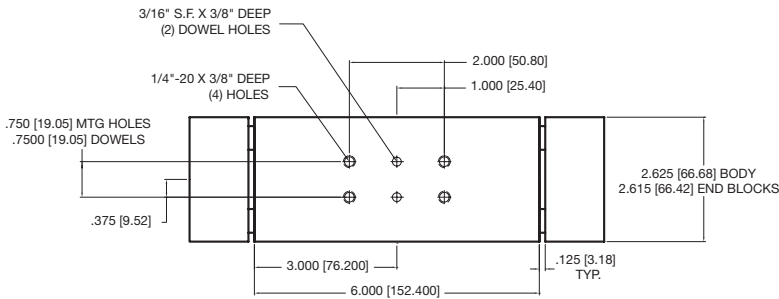

Specifications

Load Capacity	WBGX200
Grip Force @ 80 psi	84 lbs
Stroke	4 in.
Repeatability	+/- 0.002
Operating Temp.	-20°/180°F
Max. Actuation Speed	0.5 sec
Maximum Pressure	120 psi
Unit Weight	6 lbs

Static Condition

Load Capacity	WBGX200
C-compression	500 lbs.
T-tension	500 lbs.
Mx	500 in.-lbs.
My	750 in.-lbs.
Mz	500 in.-lbs.

Dynamic Condition

Load Capacity	WBGX200
C-compression	50 lbs.
T-tension	50 lbs.
Mx	50 in.-lbs.
My	75 in.-lbs.
Mz	50 in.-lbs.

WBGX-200

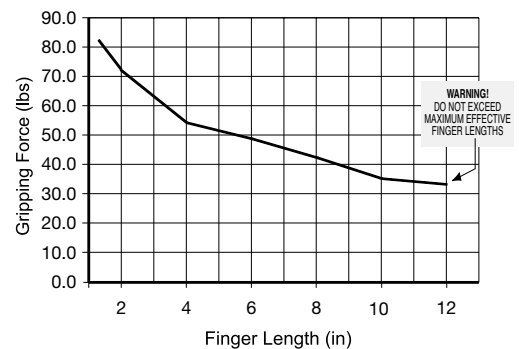

Dimensions: Inches (mm)

WBGs 300 Series

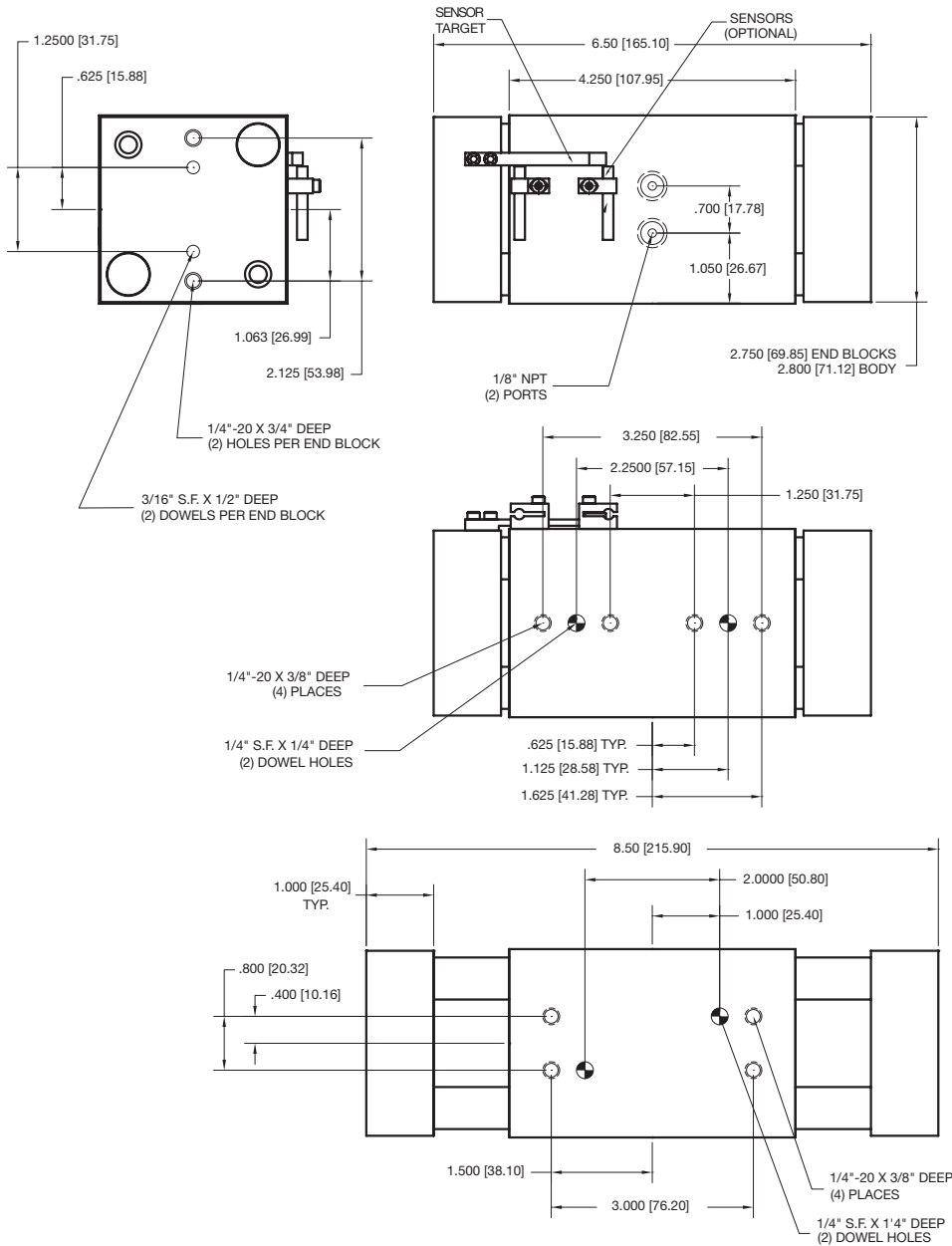

Specifications

Load Capacity	WBGs300
Grip Force @ 80 psi	130 lbs
Stroke	2 in.
Repeatability	+/- 0.002
Operating Temp.	-20°/180°F
Max. Actuation Speed	0.3 sec
Maximum Pressure	120 psi
Unit Weight	6.3 lbs

Static Condition

Load Capacity	WBGs300
C-compression	1300 lbs.
T-tension	1300 lbs.
Mx	1100 in.-lbs.
My	1500 in.-lbs.
Mz	1100 in.-lbs.

Dynamic Condition

Load Capacity	WBGs300
C-compression	150 lbs.
T-tension	150 lbs.
Mx	120 in.-lbs.
My	130 in.-lbs.
Mz	120 in.-lbs.

WBGs-300

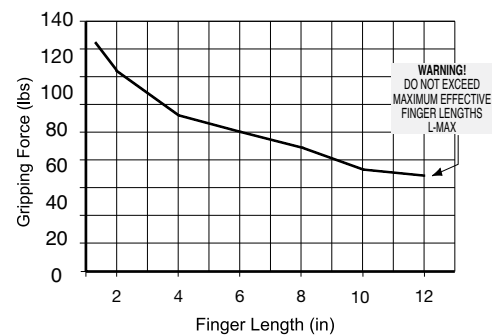

Dimensions: Inches (mm)

WBGL 300 Series

Specifications

Load Capacity	WBGL300
Grip Force @ 80 psi	130 lbs
Stroke	4 in.
Repeatability	+/- 0.002
Operating Temp.	-20°/180°F
Max. Actuation Speed	0.3 sec
Maximum Pressure	120 psi
Unit Weight	8 lbs

Static Condition

Load Capacity	WBGL300
C-compression	1300 lbs.
T-tension	1300 lbs.
Mx	1100 in.-lbs.
My	1500 in.-lbs.
Mz	1100 in.-lbs.

Dynamic Condition

Load Capacity	WBGL300
C-compression	150 lbs.
T-tension	150 lbs.
Mx	120 in.-lbs.
My	130 in.-lbs.
Mz	120 in.-lbs.

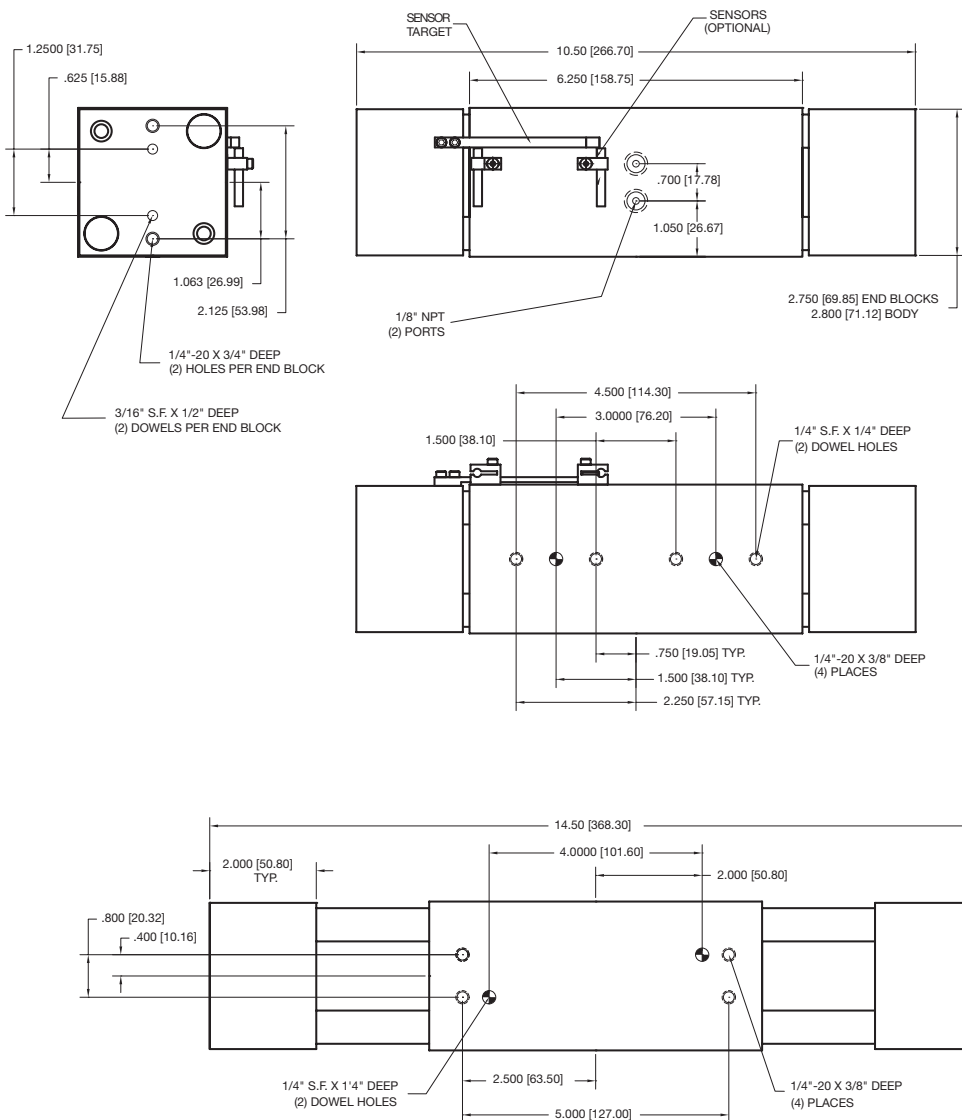

WBGL-300

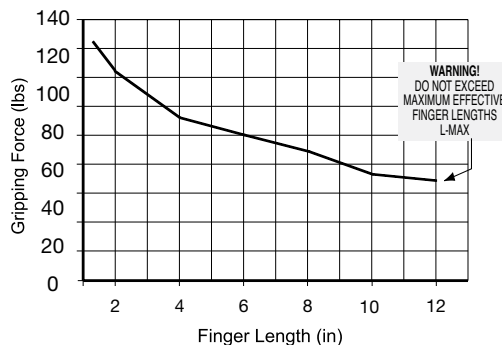

Dimensions: Inches (mm)

WBGX 300 Series

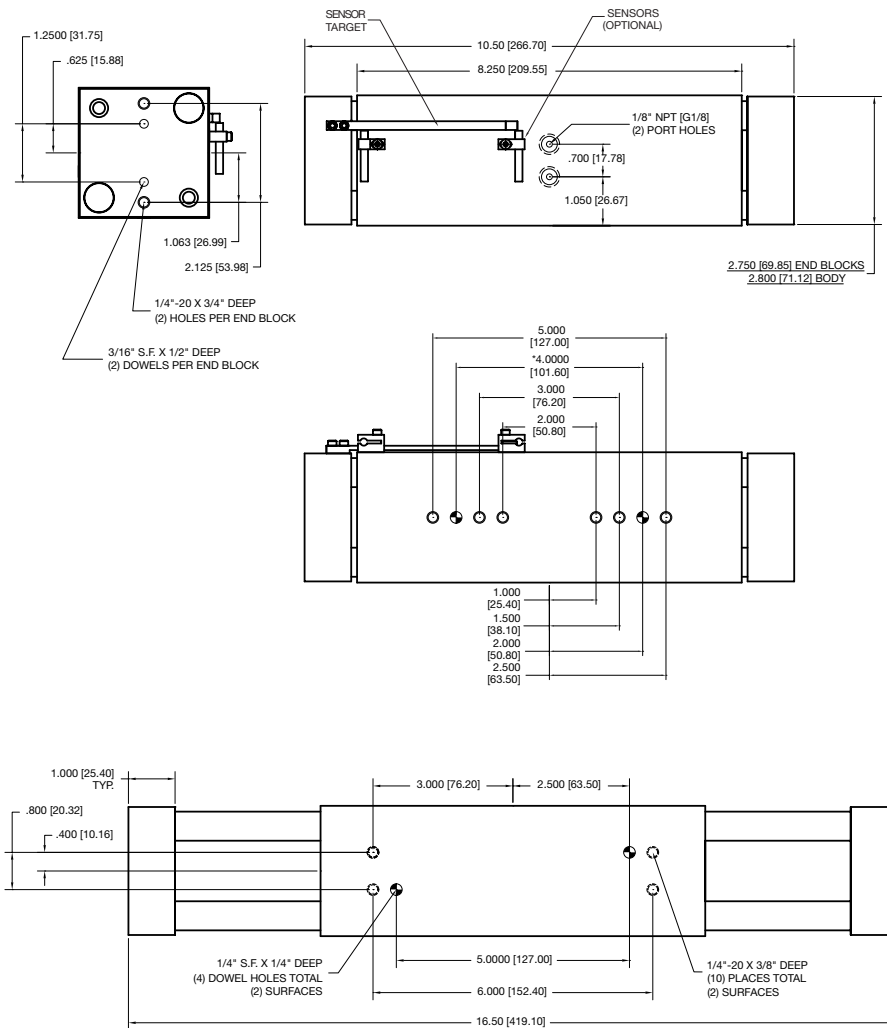

Specifications

Load Capacity	WBGX300
Grip Force @ 80 psi	130 lbs
Stroke	6 in.
Repeatability	+/- 0.002
Operating Temp.	-20°/180°F
Max. Actuation Speed	0.3 sec
Maximum Pressure	120 psi
Unit Weight	9.7 lbs

Static Condition

Load Capacity	WBGX300
C-compression	1300 lbs.
T-tension	1300 lbs.
Mx	1100 in.-lbs.
My	1500 in.-lbs.
Mz	1100 in.-lbs.

Dynamic Condition

Load Capacity	WBGX300
C-compression	150 lbs.
T-tension	150 lbs.
Mx	120 in.-lbs.
My	130 in.-lbs.
Mz	120 in.-lbs.

WBGX-300

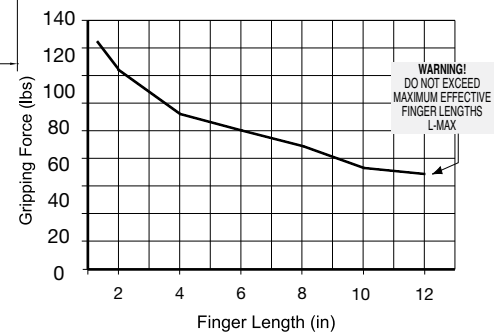

WBG Series Gripper

Bore	Bracket P/N
WBG	CT-500



Sensor Description	Standard Cord Set	Quick Disconnect
Prox PNP	PROX-4FL2-P	PROX-4QDS-P
Prox NPN	PROX-4FL2-N	Not Available

See page 19 for sensor specifications

Prox Switch (NPN NO) Flying Lead - PROX-4FL2-N
Prox Switch (PNP NO) Flying Lead - PROX-4FL2-P

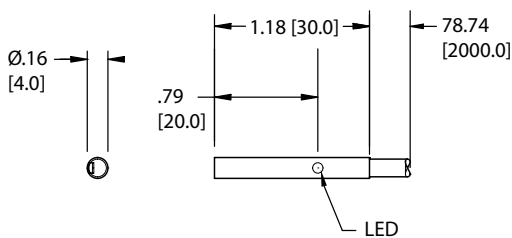

<p>PNP N/O</p> <p>1 → BN</p> <p>4 → BK</p> <p>3 → BU</p> <p>NPN N/O</p> <p>1 → BN</p> <p>4 → BK</p> <p>3 → BU</p>	<p>Electrical Design</p> <p>Output</p> <p>Operating Voltage</p> <p>Current Rating</p> <p>Short Circuit Protection</p> <p>Overload Protection</p> <p>Reverse Polarity Protection</p> <p>Voltage Drop</p> <p>Current Consumption</p> <p>Real Sensing Range</p> <p>Switching Frequency</p> <p>Ambient Temperature Protection</p> <p>Switch-Point Drift</p> <p>Hysteresis</p> <p>Operating Distance</p> <p>Correction Factor</p> <p>Housing Material</p> <p>Function Display Switching Status Connection</p>	<p>3-Wire DC PNP/NPN</p> <p>Normally Open</p> <p>10-36 VDC</p> <p>100 mA</p> <p>Yes (Non-Latching)</p> <p>Yes</p> <p>Yes</p> <p>< 2.5V</p> <p>< 15 mA @ 24V</p> <p>.8mm ± 10%</p> <p>> 2000 Hz</p> <p>-25°C to 70°C</p> <p>IP 65, III</p> <p>-10 - 10% OF Sr</p> <p>1 - 15% OF Sr</p> <p>0 - .65mm</p> <p>Mild Steel=.1, Stainless Steel=.7, Brass=.5, Alum.=.4, Copper=.3</p> <p>Housing; Stainless Steel: POM</p> <p>Yellow LED</p> <p>PVC Cable, 2m, 3 x .14mm2</p>
---	--	---

Prox Switch (PNP NO), 8 mm connector - PROX-4QDS-P

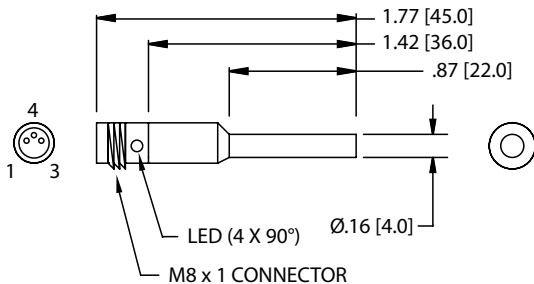

<p>Electrical Design</p> <p>Output</p> <p>Operating Voltage</p> <p>Current Rating</p> <p>Short-Circuit Protection</p> <p>Overload Protection</p> <p>Reverse Polarity Protection</p> <p>Voltage Drop</p> <p>Current Consumption</p> <p>Real Sensing Range</p> <p>Switching Frequency</p> <p>Ambient Temperature Protection</p> <p>Switch-Point Drift</p> <p>Hysteresis</p> <p>Operating Distance</p> <p>Correction Factor</p> <p>Housing Material</p> <p>Function Display Switching Status Connection</p> <p>Remarks</p> <p>Accessories</p> <p>Agency Approvals</p>	<p>3-Wire DC PNP</p> <p>Normally Open</p> <p>10-36 VDC</p> <p>100 mA</p> <p>Yes (Non Latching)</p> <p>Yes</p> <p>Yes</p> <p>< 2.5 V</p> <p>< 15 mA @ 24V</p> <p>8mm ± 10%</p> <p>> 2000 Hz</p> <p>-25°C to 70°C</p> <p>IP 67*, III</p> <p>-10 - 10% OF Sr</p> <p>1 - 15% OF Sr</p> <p>0 - .65mm</p> <p>Mild Steel=.1, Stainless Steel=.7, Brass=.5, Alum.=.4, Copper=.3</p> <p>Housing: Stainless; POM</p> <p>Red LED (4 X 90°)</p> <p>M8 Connector</p> <p>cULus- Class 2 Source Required</p> <p>Mounting Clamp</p>
--	--



*Switches are not designed for wet environments. Please see your distributor for additional information.

Quick Disconnect Cables

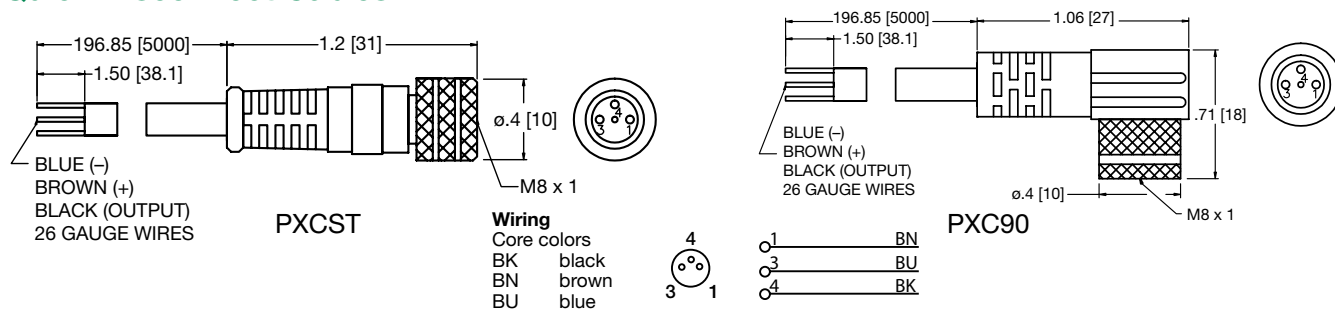

Order Code	Type	Operating Voltage	Current Rating	Cable Material	Protection	Connector
PXCST	Straight 5 m Cable (3 x 26 Gauge wire)	60 AC/75 DC	3 A	PUR	IP 68, III	M8
PXC90	90° 5 m Cable (3 x 26 Gauge wire)	60 AC/75 DC	3 A	PUR	IP 68, III	M8

NUMATICS®

World Class Supplier of Pneumatic Components



World Headquarters

USA Numatics, Incorporated

46280 Dylan Drive
Novi, Michigan 48377

P: 248-596-3200
F: 248-596-3201

Canada Numatics, Ltd

P: 519-758-2700
F: 519-758-5540

México - Ascomatica SA de CV

P: 52 55 58 09 56 40 (DF y Area metropolitana)
P: 01 800 000 ASCO (2726) (Interior de la República)
F: 52 55 58 09 56 60

Brazil Ascoval Ind.e Comercio Ltda

P: (55) 11-4208-1700
F: (55) 11-4195-3970